

This manual should be considered a permanent part of the motorcycle and should remain with the motorcycle when resold or otherwise transferred to a new owner or operator. The manual contains important safety information and instructions which should be read carefully before operating the motorcycle.

FOREWORD

THANK YOU for choosing **Hyosung** motorcycle. We at **Hyosung** have designed, tested and produced this motorcycle using the most modern technology available to provide you with much happy, enjoyable, safe riding. Motorcycling is one of the most exhilarating sports and insure your riding enjoyment, you should become thoroughly familiar with the information presented in this Owner's Manual before riding the motorcycle.

The proper care and maintenance that your motorcycle requires are outlined in this manual.

By following these instructions explicitly you will insure a long trouble-free operating life for your motorcycle. Your **Hyosung** dealer has experienced technicians that are trained to provide your machine with the best possible service with the right tools and equipment.

All information, illustrations photographs and specifications contained in this manual are based on the latest product information available at the time of publication. Due to improvements or other changes, there may be some discrepancies in this manual. Hyosung reserves the right to make changes at any time.

Please note that this manual applies to all specifications for all respective destinations and explains all equipments. Therefore, your model may have different standard features than shown in this manual.

 HYOSUNG MOTORS & MACHINERY INC.

© COPYRIGHT HYOSUNG MOTORS & MACHINERY INC.

IMPORTANT

BREAK-IN INFORMATION FOR YOUR MOTORCYCLE

The first 1,600km(1,000miles) are the most important in the life of your motorcycle.

Proper break-in operation during this time will help ensure maximum life and performance from your new motorcycle.

Hyosung parts are manufactured of high quality materials, and manufactured parts are finished to close tolerances. Proper break-in operation allows the machined surfaces to polish each other and mate smoothly.

Motorcycle reliability and performance depend on special care and restraint exercise during the break-in period. It is especially important that you avoid operating the engine in a manner which could expose the engine parts to excessive heat.

Please refer to the BREAK-IN section for specific break-in recommendations.

WARNING/CAUTION/NOTE

Please read this manual and follow its instructions carefully. To emphasize special information the words 『WARNING』, 『CAUTION』 and 『NOTE』.



WARNING

The personal safety of the rider may be involved. Disregarding this information could result in injury to the rider.



CAUTION

These instructions point out special service procedures or precautions that must be followed to avoid damaging the machine.

NOTE

This provides special information to make maintenance easier or important instructions clearer.

 **WARNING**

Noise Control System(muffler assembly)

TAMPERING WITH NOISE CONTROL SYSTEM PROHIBITED

Owners are warned that the law may prohibit :

- (a) The removal or rendering inoperative by any person other than for the purpose of maintenance, repair or replacement, of any device or element of design incorporated into any new vehicle for the purpose of noise control prior to its any sale or delivery to the ultimate purchaser or while it is in use ; and
- (b) The use of the vehicle after such device or element of design has been removed or rendered inoperative by any person.

MAINTENANCE:

The exhaust system of this motorcycle requires no periodic maintenance. The engine should be adjusted to the manufacture' s specifications and the spark plug should be kept in good condition. Running the engine with incorrectly operating spark plug or misadjusted carburetor may cause permanent damage to the catalyst and to the noise control system.

CONSUMER INFORMATION

SAFE RIDING RECOMMENDATION FOR MOTORCYCLE RIDERS

Motorcycle riding is great fun and an exciting sport. Motorcycle riding also requires that some extra precautions be taken to ensure the safety of the rider and passenger. These precautions are:



WARNING

- Before first use of the *“Aquila”*, read this owner’s manual carefully to become familiar with the *“Aquila”*’s features, and safety and maintenance requirements. Review all instructions, requirements and warnings with the riders. Keep the owner’s manual in the owner’s manual storage compartment located under the seat.
- Before the rider’s first use of the *“Aquila”*, make sure that he / she is familiar with the location and operation of all controls, and has been instructed in the proper operation of the motorcycle.
- For first use of the *“Aquila”*, find a level, open area for the rider to use to become familiar with the operation of controls and the operating and handling characteristics of the *“Aquila”*.



WARNING

- Before each use, perform daily inspections with the rider. Specific items to check are listed in the **INSPECTION BEFORE RIDING** section on page 46 of this owner’s manual.
- Make sure the rider wears a helmet, eye protection, and protective clothing (gloves, leather or heavy cloth pants, long sleeved shirt or jacket, boots).
- Permit use only by dual rider. This motorcycle is designed for use only by dual rider.
- Do not permit anyone to operate the *“Aquila”* under the influence of alcohol or other drugs caused by damage to the motorcycle or altered handling characteristics.
- Observe periodic maintenance requirements your authorized HYOSUNG dealer is trained and equipped to perform this service.
- Drain gasoline from the fuel tank and carburetor prior to transporting the *“Aquila”*.
- Caution the rider and others near the *“Aquila”* not to get close to or touch any moving parts or any heated areas such as the engine and exhaust system.
- Do not make any modifications to the *“Aquila”*. Modifications may make the motorcycle unsafe or illegal in your state.



WARNING

The *“Aquila”* is equipped with the side stand ignition interlock system.

If the transmission is in neutral or side stand up, you can only start the engine with pulling in the clutch lever.

This side stand ignition interlock system prevents the motorcycle from being started with side stand down.

Make sure that the side stand ignition interlock system is working properly before riding.



CAUTION

This motorcycle always come on the head lamp and tail lamp when starting engine.



WARNING

- Do not run the engine indoors or where there is little or no ventilation. Exhaust gases contain carbon monoxide, a potentially lethal gas that is colorless and odorless.
- Never leave the motorcycle running while unattended, even for a short time.



WARNING

While operating the *“Aquila”*, the rider should keep both feet on the footrests at all times, or injuries resulting from accidents. Moving the rider's feet from the footrests reduces the rider's ability to control the motorcycle, and could lead to an accident.



WARNING

Keep both hands on the handgrips at all times when riding. Removing your hands from the handgrips reduces your ability to control the motorcycle, and could result in an accident.



WARNING

Always open the throttle gradually to prevent front wheel lifting. Failure to observe this precaution may result in loss of control and an accident.



CAUTION

WHEN KEEPING FOR LONG PERIOD :

1. Supply the enough fuel in the fuel tank.
2. Do drain wholly the fuel in the carburetor.
3. Remove the battery from the motorcycle.

WARNING

Do not operate the ignition switch in the "OFF" position, the steering lock to lock or the engine stop switch in the "X" position while driving at one's pleasure.

⦿ WEAR A HELMET

WARNING

Motorcycle safety equipment starts with a quality safety helmet. One of the most serious injuries that can happen is a head injury. **ALWAYS** wear a properly approved helmet. You should also wear a suitable eye protection.

⦿ RIDING APPAREL

WARNING

Loose fancy clothing can be uncomfortable and unsafe in terms of riding your motorcycle.

Choose good quality motorcycle riding apparel in terms of riding your motorcycle.

⦿ INSPECTION BEFORE RIDING

WARNING

Review thoroughly the instructions in the "INSPECTION BEFORE RIDING" section of this manual. Do not forget to perform an entire safety inspection to ensure the safety of the rider and its passenger.

⦿ FAMILIARIZE YOURSELF WITH THE MOTORCYCLE

WARNING

Your riding skill and mechanical knowledge from the foundation for safe riding practices.

We suggest that you practice riding your motorcycle in a non-traffic situation until you are thoroughly familiar with your machine and its controls. Remember practice makes perfect.

⦿ KNOW YOUR LIMITS

WARNING

Ride within the boundaries of your own skill at all times. Knowing these limits and staying within them will help you to avoid accidents.

⦿ BE EXTRA SAFETY CONSCIOUS ON BAD WEATHER DAYS

WARNING

Riding on bad weather days, especially wet ones, requires extra caution.

Braking distances double on a rainy day. Stay off of the painted surface marks, manhole covers and greasy appearing areas as they can be especially slippery.

Use extreme caution at railway crossings and on metal gratings and bridges. Whenever you have a doubt about road condition, slow down!

ACCESSORY INSTALLATION AND PRECAUTION SAFETY TIPS

There are a great variety of accessories available to **Hyosung** owners. **Hyosung** can not have direct control over the quality or suitability of accessories you may wish to purchase except genuine parts.

The addition of unsuitable accessories can lead to unsafe operating conditions. It is not possible for **Hyosung** to test each accessory on the market or combinations of all the available accessories, however, your dealer can assist you in selecting quality accessories and installing them correctly.

Use extreme caution when selecting and installing the accessories for your **Hyosung**. We have developed some general guidelines which will aid you when deciding whether, and how to equip your motorcycle.

1. In case that additional weight or aerodynamic affecting accessories are installed, they should be mounted as low as possible, as close to the motorcycle and as near the center of gravity as is feasible. The mounting brackets and other attachment hardware should be carefully checked to ensure that it provides for a rigid, nonmovable mount. Weak mounts can allow the shifting of the weight and create a dangerous, unstable condition.
2. Inspect for proper ground clearance and bank angle. An improperly mounted load could critically reduce these two safety factors. Also determine that

the “load” does not interfere with the operation of the suspension, steering or other control operations.

3. Accessories fitted to the handlebars or the front fork area can create serious stability problems. This extra weight will cause the motorcycle to be less responsive to your steering control. The weight may also cause oscillations in the front end and lead to instability problems. Accessories added to the machine should be as light as possible and kept to a minimum.
4. The motorcycle may be affected by a lifting condition or by an instability in cross winds or when being passed or passing large vehicles. Improperly mounted or poorly designed accessories can result in an unsafe riding condition, therefore caution should be used when selecting and installing all accessories.
5. Certain accessories displace the rider from his or her normal riding position. This limits the freedom of movement of the rider and may limit his or her control ability.
6. Additional electrical accessories may damage the existing electrical system. Severe overloads may damage the wiring harness or create a dangerous situation due to the loss of electrical power during the operation of the motorcycle.

When carrying a load on the motorcycle, mount it as low as possible and as close as possible to the machine. An improperly mounted load can create a high center of gravity which is very dangerous and makes the motorcycle difficult to handle. The size of the “load” can also affect the aerodynamics and handling of the motorcycle.

Balance the load between the left and right side of the motorcycle and fasten it securely.



WARNING

Modification of the motorcycle, or removal of original equipment may render the vehicle unsafe or illegal.

TABLE OF CONTENTS

| | |
|---|-----------|
| 1. SERIAL NUMBER LOCATION | 12 |
| 2. FUEL , ENGINE OIL AND COOLANT RECOMMENDATION . . . | 12 |
| FUEL | |
| ENGINE OIL | |
| COOLANT | |
| 3. NAMES OF EACH PARTS | 15 |
| 4. CONTROLS | 18 |
| IGNITION SWITCH | |
| STEERING LOCK | |
| IGNITION KEY | |
| INSTRUMENT PANEL | |
| LEFT HANDLE SWITCH | |
| RIGHT HANDLE SWITCH | |
| CARBURETOR CHOKE LEVER | |
| REAR BRAKE PEDAL | |
| GEARSHIFT LEVER | |
| FOOTRESTS | |
| SIDE STAND | |
| SEAT LOCK | |
| REAR SHOCK ABSORBER | |
| FRONT FORK | |
| FUEL TANK STAY | |
| 5. SUPPLY OF GASOLINE , ENGINE OIL AND COOLANT | 34 |
| GASOLINE | |
| ENGINE OIL | |
| COOLANT | |
| 6. RIDING TIPS | 40 |
| STARTING THE ENGINE | |
| STARTING OFF | |
| USING THE TRANSMISSION | |
| RIDING ON HILLS | |
| STOPPING AND PARKING | |

| | |
|---|-----------|
| 7. BREAK-IN | 45 |
| 8. INSPECTION BEFORE RIDING | 46 |
| 9. PERIODIC MAINTENANCE | 47 |
| 10. INSPECTION AND MAINTENANCE | 50 |
| TOOL | |
| ENGINE OIL | |
| GASOLINE | |
| FUEL HOSE | |
| COOLANT | |
| RADIATOR | |
| RUBBER CAP OF CABLES | |
| EXHAUST PIPE AND MUFFLER | |
| FRONT FORK | |
| REAR SHOCK ABSORBER | |
| BATTERY | |
| AIR CLEANER | |
| SPARK PLUG | |
| CARBURETOR | |
| CLUTCH ADJUSTMENT | |
| DRIVE BELT | |
| BRAKES | |
| TIRE | |
| REPLACEMENT OF THE LAMP | |
| WHEN THE ENGINE REFUSES TO START | |
| WHEN KEEPING FOR LONG PERIOD | |
| CLEANING PROCEDURE | |
| 11. LABEL | 69 |
| 12. SPECIFICATIONS | 71 |

SERIAL NUMBER LOCATION

The frame and/or engine serial numbers are used to register the motorcycle. They are also to assist your dealer in terms of ordering parts or referring to special service information.

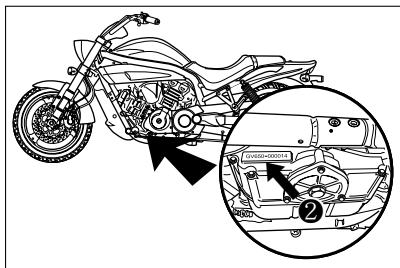
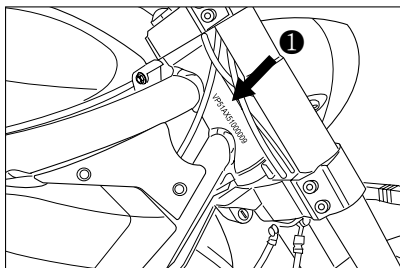

The frame serial number ① is stamped on the steering head tube.

The engine serial number ② is stamped on the left downside of the crankcase assembly.

Please write down the numbers in the box provided below for your future reference.

Frame number :

Engine number :

FUEL, ENGINE OIL AND COOLANT RECOMMENDATION

FUEL

Use unleaded gasoline with an octane rating of 91 or higher.

Unleaded gasoline can extend spark plug life and exhaust components life.

⚠ CAUTION

Spilling gasoline can damage the painted surfaces.

Be careful not to spill any fuel when filling the fuel tank.

Wipe spilled gasoline up immediately.

⚠ WARNING

- When refueling, always shut the engine off and turn the ignition key to the "OFF" position. Never refuel near the flames, sparks and heat sources.
- Do not overfill the fuel tank. Do not fill gasoline above the fuel tank entrance lower end.

ENGINE OIL

⊙ ENGINE OIL SPECIFICATION

| Classification system | Grade | Remarks |
|-----------------------|---------|---------|
| API | Over SL | |
| SAE | 10W/40 | |

※ If a SAE 10W/40 motor oil is not available, select alternative according to the following chart.

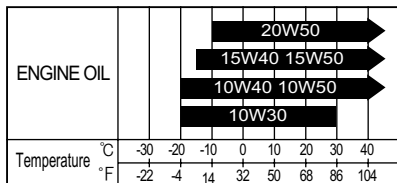

Using a premium quality four stroke motor oil will increase the service life of your motorcycle.



WARNING

- Don't mix the unrecommended oil. It could damage the engine.
- When refilling the oil, don't allow the dust to get inside.
- Mop the oil spilt.
- Don't put the patch on the filler cap. It could disturb the oil to be provided and damage the engine.

COOLANT

Use an anti-freeze compatible with aluminium radiator mixed with distilled water only at the ratio of 50:50



WARNING

Engine coolant is harmful or fatal if swallowed or inhaled.

Do not drink anti-freeze or coolant solution. If swallowed, do induce vomiting. Immediately contact a poison control center or a physician. Avoid inhaling mist or hot vapors ; if inhaled, remove to fresh air. If coolant gets in eyes, flush eyes with water and seek medical attention. Wash thoroughly after handling. Solution can be poisonous to animals. Keep out of the reach of children and animals.



CAUTION

Spilled engine coolant can damage painted surfaces.

Do not spill any fluid when filling the radiator. Wipe spilled engine coolant up immediately.

⊙ WATER FOR MIXING

Use distilled water only. Water other than distilled water can corrode and clog the aluminium radiator.

⊙ ANTI-FREEZE

The coolant performs as rust inhibitor and water pump lubricant as well as anti-freeze. Therefore the coolant should be used at all times even though the atmospheric temperature in your area does not go down to freezing point.

| Required amount of water/coolant | |
|----------------------------------|-------|
| Solution capacity(total) | 1.6 l |

| | | |
|-----|---------|-------|
| 50% | Water | 0.8 l |
| | Coolant | 0.8 l |

NOTE

This 50% mixture will protect the cooling system from freezing at temperatures above -31°C. If the motorcycle is to be exposed to temperature below -31°C, this mixing ratio should be increased up to 55% (-40°C) or 60% (-55°C). The mixing ratio should not exceed 60%.

⊙ COOLANT RESERVOIR TANK

☞ Refer to 38 page.

NAMES OF EACH PART

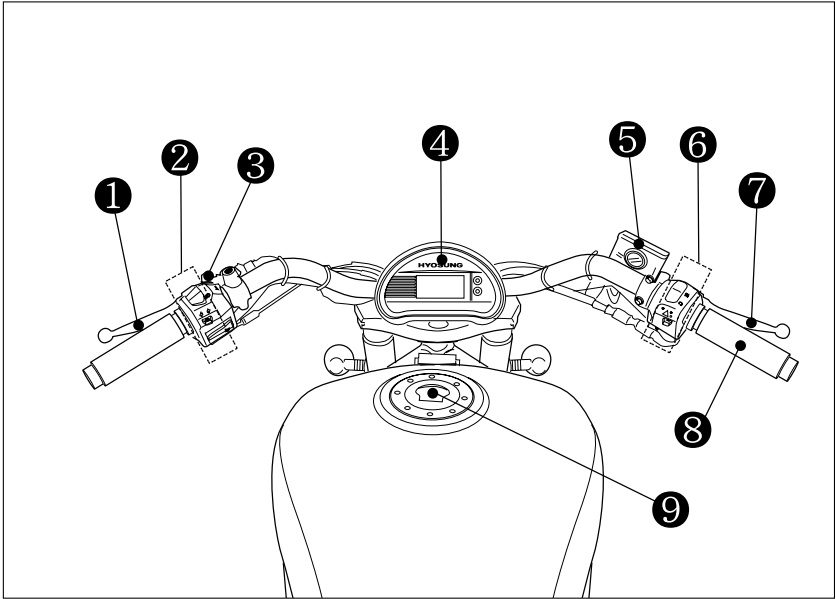

- ① Clutch lever
- ② Left handle switches
- ③ Choke lever
- ④ Instrument panel
- ⑤ Front brake fluid reservoir

- ⑥ Right handle switches
- ⑦ Front brake lever
- ⑧ Throttle grip
- ⑨ Fuel tank cap

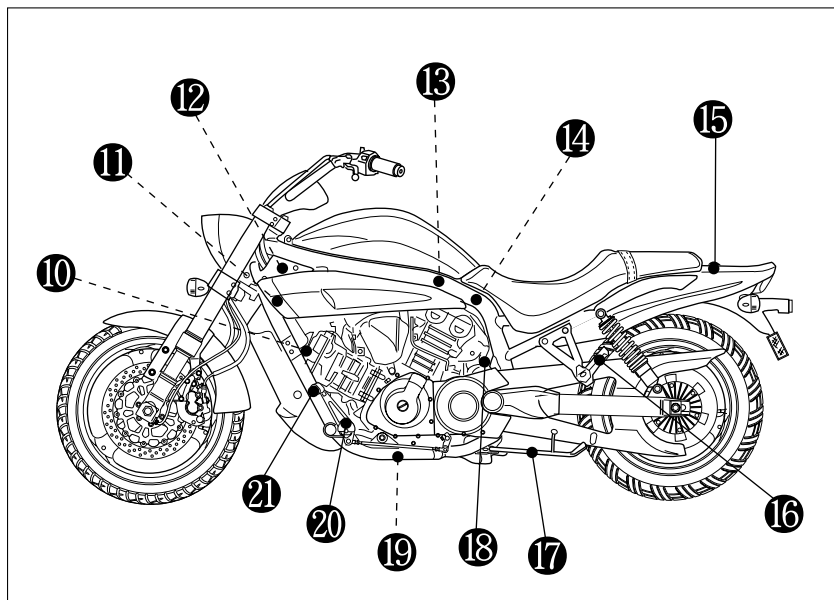

- | | |
|-------------------------|-------------------------|
| ⑩ Spark plug (Front) | ⑯ Passenger footrests |
| ⑪ Ignition coil (Front) | ⑰ Side stand |
| ⑫ Fuses | ⑱ Coolant reserve tank |
| ⑬ Ignition coil (Rear) | ⑲ Engine oil drain plug |
| ⑭ Spark plug (Rear) | ⑳ Footrests |
| ⑮ Seat lock bolt | ㉑ Gearshift lever |

NOTE

“-----” : means the invisible parts.

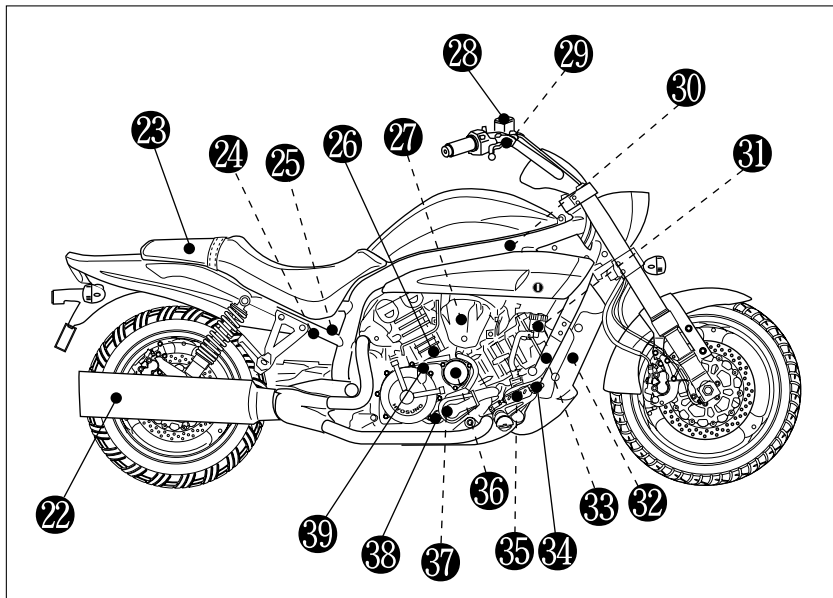

- | | |
|-------------------------------|-------------------------------|
| ② Muffler | ③① Rear brake fluid reservoir |
| ③ Seat | ④ Radiator |
| ④ Battery | ⑤ Cooling fan and motor |
| ⑤ Tools | ⑥ Rear brake pedal |
| ⑥ Throttle stop screw | ⑦ Rear brake lamp switch |
| ⑦ Fuel pump | ⑧ Engine oil filter |
| ⑧ Front brake fluid reservoir | ⑨ Water pump |
| ⑨ Front brake lamp switch | ⑩ Engine oil level lens |
| ⑩ Air cleaner | ⑪ Engine oil filler cap |

NOTE

“-----” : means the invisable parts.

CONTROLS

IGNITION SWITCH

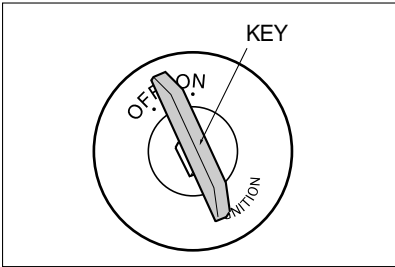

「Aquila」 have the ignition switch at the rightside.

The ignition switch has two positions :

⊙ “OFF” POSITION

All electrical circuits are cut off.

The engine will not start. The key can be removed.

⊙ “ON” POSITION

The ignition circuit is completed and the engine can now start. The key cannot be removed from the ignition switch in this position.



WARNING

Turning the ignition switch to the “OFF” position while the motorcycle is moving can be hazardous.

STEERING LOCK

『Aquila』 have the steering lock below the steering head tube.

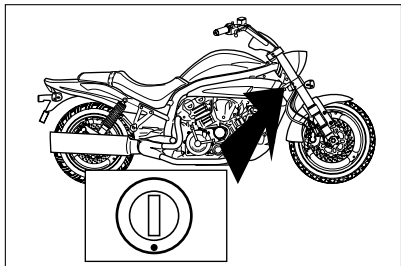

To lock the steering :

- ① Turn the handlebar all the way to the left.
- ② Insert the ignition key into the steering lock, and take a turn it from the “ ● ” position.
- ③ Remove the ignition key.



WARNING

Do not operate the steering lock while driving at one s pleasure.

Moving the motorcycle while the steering is locked can be hazardous. You could lose your balance and fall, or you could drop the motorcycle.

Stop the motorcycle and place it on the side stand if equipped before locking the steering. Never attempt to move the motorcycle when the steering is locked.

IGNITION KEY

『Aquila』 comes equipped with a pair of identical ignition keys. Keep the spare key in a safe place.

Your motorcycle ignition keys are stamped with an identifying number. This number is used when making replacement keys. Please write your key number in the box provided for your future reference.

Key number :

INSTRUMENT PANEL

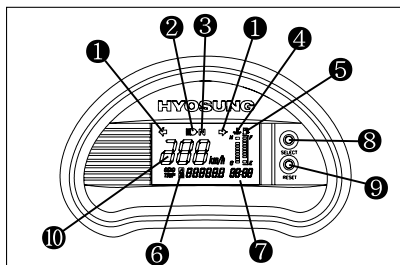

⚠ CAUTION

When the ignition switch is turned to the ON position, the display of speedometer will come on.

⚠ CAUTION

To adjust the light of speedometer display, push the switch ⑧ (in the normal mode) for 0.6 ~ 1 seconds while you want to change.

[Light of speedometer display]

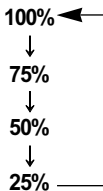

① TURN SIGNAL INDICATOR LAMP

When the turn signals are being operated either to the right or to the left, the indicator will flash at the same time.

② HIGH BEAM INDICATOR LAMP

The high beam indicator lamp will come on when the head lamp high beam is turned on.

③ NEUTRAL INDICATOR LAMP

The neutral indicator lamp will come on when the transmission is in neutral.

The lamp will go out when you shift into any gear other than neutral.

④ COOLANT TEMPERATURE METER

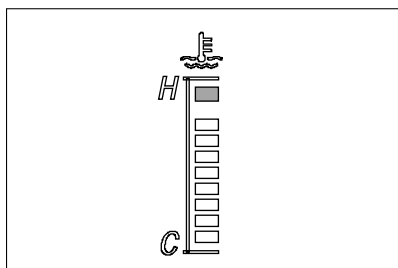

『Aquila』s the speedometer is VFD(Vacuum Fluorescent Display) type, it indicates the coolant temperature.

The H (Hot) mark indicates the coolant temperature is hot.

When the coolant temperature is higher than 125°C, the red lamp of H (Hot) mark comes on.

The C (Cool) mark indicates the coolant temperature is cool.

⚠ CAUTION

Running the engine with high engine coolant temperature can cause serious engine damage.

If the engine coolant temperature meter comes on the red lamp of "H" mark, stop the engine to let it cool.

⑤ FUEL METER

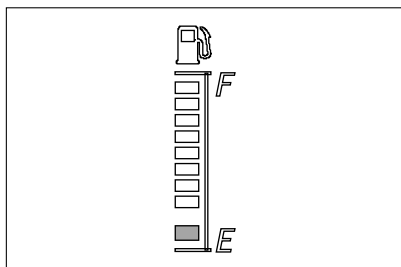

「Aquila」s the speedometer is VFD(Vacuum Fluorescent Display) type, it indicates the remaining fuel amount in the fuel tank.

The F (Full) mark indicates the fuel tank is full.

The E (Empty) mark indicates the fuel tank is empty or nearly so.

When the remaining fuel is approximately 3.0 ℓ, the red lamp of E (Empty) mark comes on only.

Fill the fuel tank before the red lamp of E (Empty) mark came on only.

The fuel tank capacity is 16.0 ℓ.

CAUTION

When the red lamp of E mark comes on only, you should add fuel to the fuel tank at the first opportunity to avoid running out of fuel.

CAUTION

For checking the fuel meter, hold the motorcycle vertically and the ignition switch ON .

⑥ ODOMETER / TRIP METER

The display in it has three functions, odometer and two trip meters.

The display changes odometer or trip meter, as indicated before turning the ignition switch off.

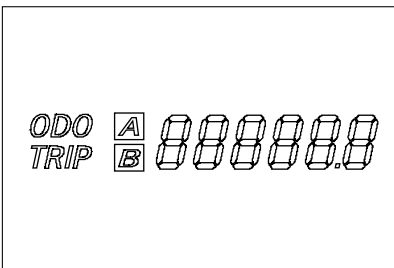

The odometer registers the total distance that the motorcycle has been ridden.

The two trip meters are resettable odometer.

They can register two kinds of distance at the same time. For instance, trip meter **A** can register the trip distance and trip meter **B** can register the distance between fuel stops.

To change the display, push the switch ⑨ (in the normal mode) for 0.6 ~ 1 seconds while the display indicates the odometer, trip meter **A** or trip meter **B** you want to change.

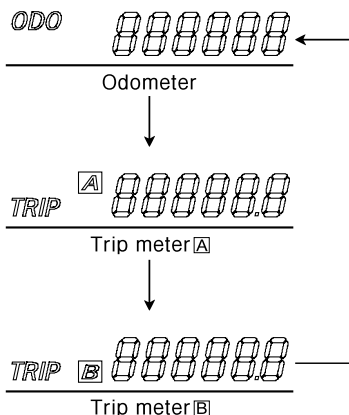

To reset the trip meter to zero, push the switch ⑨ (in the normal mode) for 2 seconds while the display indicates trip meter A or B you want to reset.



WARNING

Operating the display while riding can be hazardous. Removing a hand from the handlebars can reduce your ability to control the motorcycle.

Always keep both hands on the handlebars while riding.

⑦ CLOCK

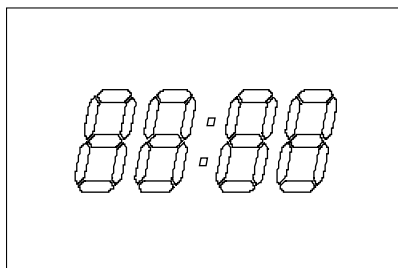

The clock indicates 12-hour mode. Follow the procedure below to adjust the clock.

1. Push the switch ⑧ (in the normal mode) for 2 seconds until the hour and minutes display blink. It is the clock reset mode.
2. Adjust the hour display by pushing the switch ⑨ (in the clock reset mode) for 0.6 ~ 1 seconds.
3. Adjust the minutes display by pushing the switch ⑧ (in the clock reset mode) for 0.6 ~ 1 seconds.
4. Push the switch ⑧ for 2 seconds to resume in the normal mode.

CLOCK ADJUSTMENT

| Mode | Switch | Push it for | Adjustment |
|------------------|-----------|-----------------|--------------------------------|
| Normal | Select(⑧) | 2 seconds | Normal mode → Clock reset mode |
| Clock reset mode | Reset(⑨) | 0.6 ~ 1 seconds | Increase the hour of clock |
| | Select(⑧) | 0.6 ~ 1 seconds | Increase the minutes of clock |
| | Select(⑧) | 2 seconds | Clock reset mode → Normal mode |

⑧ SELECT SWITCH

Use this switch to adjust the following :

● In the normal mode

| Push it for | Adjustment |
|-----------------|---|
| 0.6 ~ 1 seconds | To adjust the light of speedometer display (100% → 75% → 50% → 25% → 100%) |
| 2 seconds | Normal mode → Clock reset mode |

● In the clock reset mode

| Push it for | Adjustment |
|-----------------|-----------------------------------|
| 0.6 ~ 1 seconds | Increase the minutes of clock |
| 2 seconds | Clock reset mode → Normal mode |

⑨ RESET SWITCH

Use this switch to adjust the following :

● In the normal mode

| Push it for | Adjustment |
|-----------------|--|
| 0.6 ~ 1 seconds | Odometer → Trip meter [A] → Trip meter [B] → Odometer |
| 2 seconds | To reset the trip meter to zero, while the display indicates trip meter [A] or [B] |

● In the clock reset mode

| Push it for | Adjustment |
|-----------------|----------------------------|
| 0.6 ~ 1 seconds | Increase the hour of clock |

⑩ SPEEDOMETER

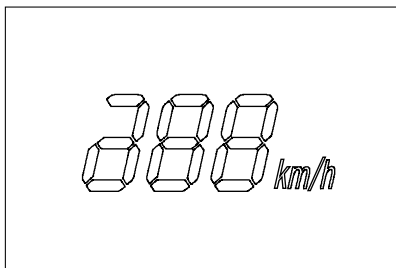
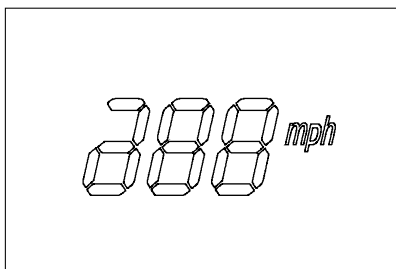

The speedometer indicates the road speed in kilometers or miles per hour.

LEFT HANDLE SWITCH

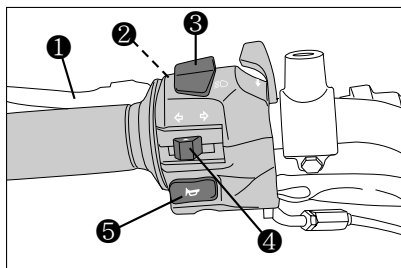

① CLUTCH LEVER

The clutch lever is used for disengaging the drive to the rear wheel when starting the engine or shifting the transmission gear.

Squeezing the lever disengages the clutch.

② “PASS” SWITCH

Press the “PASS” switch to operate the head lamp high beam for using when pass.



With the ignition switch in the “ON” position, push the “PASS” switch to operate the head lamp high beam.

⚠ CAUTION

Do not operate when the dimmer switch “” position.

③ DIMMER SWITCH

Change the direction of head lamp light.



- “” : The head lamp high beam come on.
The high beam indicator lamp also comes on.
- “” : The head lamp low beam come on.

⚠ WARNING

Set the dimmer switch “” when other vehicle is running in front or against.

④ TURN SIGNAL SWITCH

Using when left, right turn or change direction.

- “” Position : Flash the left turn signal lamp.
- “” Position : Flash the right turn signal lamp.

⚠ CAUTION

Always use the turn signals when you intend to change lanes or make a turn. Always be sure to turn the turn signal switch to the “OFF” position after completing the turn or lane change.

⑤ HORN SWITCH

Press the switch to operate the horn.

RIGHT HANDLE SWITCH

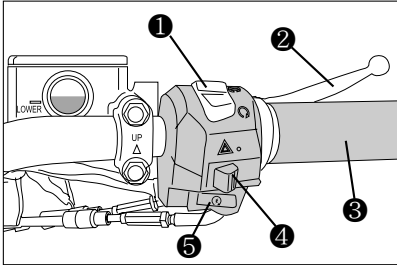

① ENGINE STOP SWITCH

- “⊗” Position : Using when dangerous condition of falling down during drive and others or engine stop suddenly. The ignition circuit is off. The engine cannot start or run.
- “○” Position : Using when need operation of engine as drive and others. The ignition circuit is on and the engine can run.



WARNING

Do not operate the engine stop switch into the “⊗” position while driving at one’s pleasure.

② FRONT BRAKE LEVER

The front brake is applied by squeezing the brake lever gently toward the throttle-grip.

Front brake be anxious about motorcycle falling down when braking suddenly as disk brake system. The brake lamp will come on when the lever is squeezed.



WARNING

Apply the brake lightly and with great care on slippery surfaces to avoid skidding.

③ THROTTLE GRIP

Engine speed is controlled by position of the throttle grip. Turn it toward you to increase engine speed. Turn it away from you to decrease the engine speed.



WARNING

Avoid turning the throttle grip during brakes.

④ HAZARD WARNING SWITCH

- “△” : All four turn signal lamp and indicator lamp will flash simultaneously when the switch is turned on with the ignition switch in “ON” position.
- “●” : The turn signal lamp and indicator lamp go off.

Use the hazard warning lamps to warn other traffic during emergency parking or when your vehicle could otherwise become a traffic hazard.

⑤ ⚡ STARTER SWITCH

Use this switch to operate the starting motor.

With the ignition switch in the “ON” position, the engine stop switch in the “○” position, and the transmission is in neutral, pull in the clutch lever and side stand up and push the starter switch to start the engine.

⚠ CAUTION

Do not engage the starting motor for more than five seconds at a time as it may overheat the wiring harness and starting motor.

If the engine does not start after several attempts, check the fuel supply and ignition system. (Refer for Page 67)

⚠ WARNING

The "Aquila" is equipped with the side stand ignition interlock system.

If the transmission is in neutral or side stand up, you can only start the engine with pulling in the clutch lever.

This side stand ignition interlock system prevents the motorcycle from being started with side stand down.

Make sure that the side stand ignition interlock system is working properly before riding.

⚠ CAUTION

This motorcycle always come on the head lamp and tail lamp when starting the engine.

CARBURETOR CHOKE LEVER

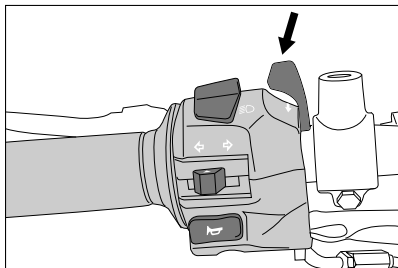

The carburetor is equipped with a choke system to provide easy starting when the engine is cold.

When starting the cold engine, turn the choke lever all the way toward you. The choke works best when the throttle is in the closed position. When the engine is warm, you do not need to use the choke system for starting.

⚠ CAUTION

If you keep running in condition of full choke lever, it causes fuel excess exhaustion, high speed not to run, it may damage ignition plug.

REAR BRAKE PEDAL

Depressing the rear brake pedal will apply the rear brake.

The brake lamp will be illuminated when the rear brake is operated.

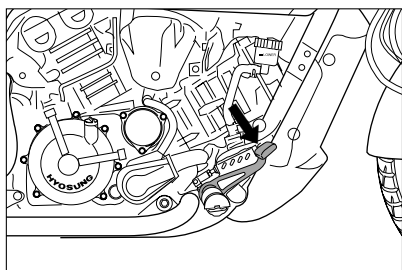

WARNING

Apply the brake lightly and with great care on slippery surfaces to avoid skidding.

GEARSHIFT LEVER

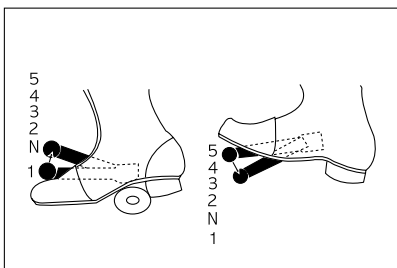
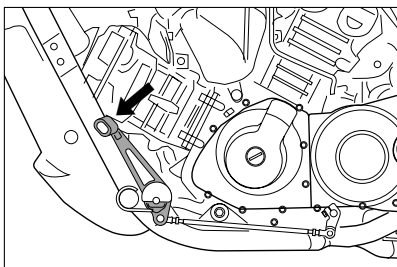

『Aquila』 has a 5-speed transmission which operates as shown.

To shift properly, pull the clutch lever and close the throttle at the same time you operate the gearshift lever. Whenever a gear is selected, the gearshift lever will return to its normal position ready to select the next gear.

Lift the gearshift lever to upshift and depress the lever to downshift.

Neutral is located between first and 2nd gear.

When neutral is desired, depress or lift the lever halfway between first and 2nd gear.

It is not possible to upshift or downshift more than one gear at a time.

When shifting from first to 2nd gear or 2nd gear to low, neutral will be automatically skipped.

Reduce the motorcycle speed before down-shifting.

When down-shifting, the engine speed should be increased before the clutch is engaged.

This will prevent unnecessary wear on the drive train components and the rear tire.

CAUTION

When the transmission is in neutral the green indicator lamp on the instrument panel will be lit.

However, even though the light is illuminated, cautiously release the clutch lever slowly to determine whether the transmission is positively in neutral.

FOOTRESTS

ⓐ FOOTREST POSITION ADJUSTMENT

『Aquila』 has 2 type of the footrest position, right and left.

To change the position, remove the footrest mounting bolt ①, footrest boss cap ② and bolt ③.

Install the bolt ① to the desired position and footrest boss cap ②, bolt ③ to the position ⓐ.

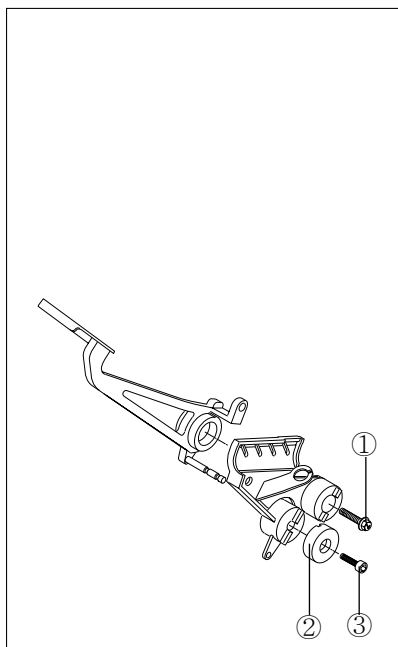

[POSITION ⓐ]

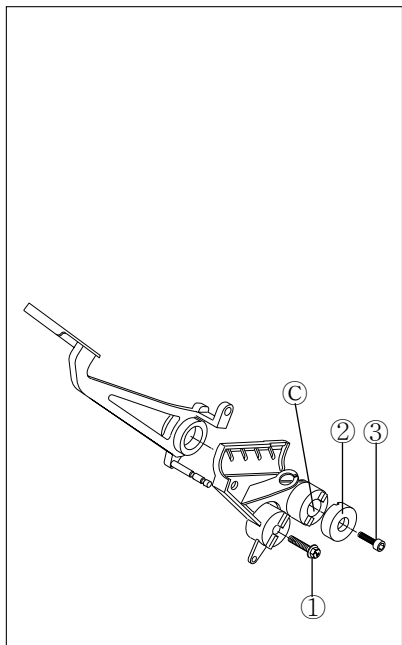

[POSITION ②]

「Aquila」 is delivered from the factory on position ①.



WARNING

When adjusting the footrest position, the footrest mounting bolt be torqued to the proper specification.

If they are not, the footrest can come off unexpectedly.

Tighten Torque

| | |
|------------------------|--------------------------------------|
| Footrest mounting bolt | 4.0 ~ 6.0 kgf · m (40 ~ 60 N · m) |
|------------------------|--------------------------------------|

Ⓞ GEARSHIFT LINK ROD

When the footrests in position ②, exchange the gearshift link rod for appropriate riding position.

● Position ①

: Install the gearshift link rod ④

● Position ②

: Install the gearshift link rod ⑤

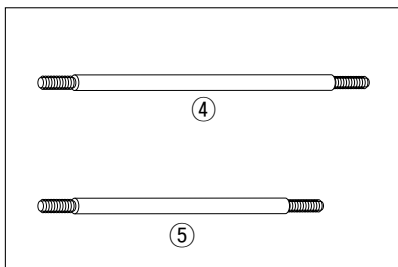
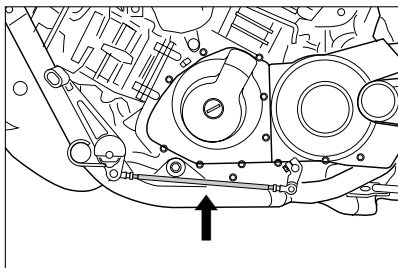

SIDE STAND

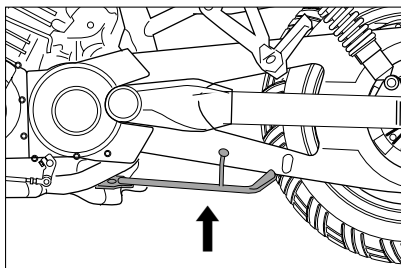

「*Aquila*」 is equipped with the side stand ignition interlock system.

If the transmission is in neutral or side stand up, you can only start the engine with pulling in the clutch lever.

This side stand ignition interlock system prevents the motorcycle from being started with side stand down.

| NO | Neutral switch | Clutch lever | Side stand | Engine start |
|----|----------------|--------------|------------|--------------|
| 1 | ● | ● | △ | Possible |
| 2 | △ | ● | ● | Possible |
| 3 | ● | △ | △ | Impossible |
| 4 | △ | ● | △ | Impossible |
| 5 | △ | △ | ● | Impossible |

NOTE

| | |
|---|-------------|
| ● | On or Up |
| △ | Off or Down |

WARNING

Make sure that the side stand ignition interlock system is working properly before riding.

SEAT LOCK

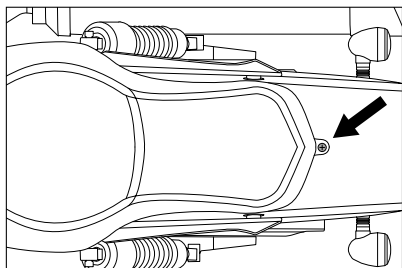

To remove the seat, remove the seat mounting bolt on the rearside of the seat.

To install the seat, slide the seat hook into the seat hook retainer and install the seat mounting bolt.

REAR SHOCK ABSORBER

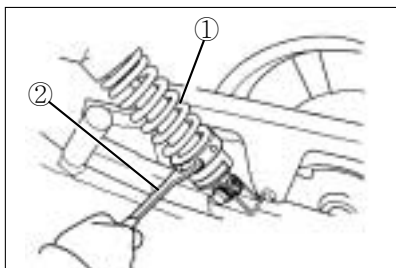

- ① Rear shock absorber
- ② Pin spanner

WARNING

Unequal suspension adjustment can cause poor handling and loss of stability. Adjust the right and left shock absorber to the same settings.

To adjust the spring pre-load, turn the adjuster clockwise or counter-clockwise to the desired position with the pin spanner.

Position 1 provides the softest spring pre-load and position 5 provides the stiffest.

‘*Aquila*’ is delivered from the factory with its adjuster set on position 1.

FRONT FORK

The standard settings of front forks are selected to meet various riding conditions such as low to high motorcycle speed and light to heavy load on the motorcycle.

The front forks settings can be adjusted for your preference and fine-tuning.

• DAMPING FORCE ADJUSTMENT

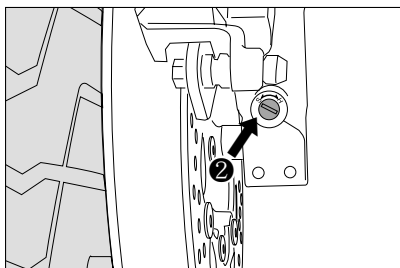
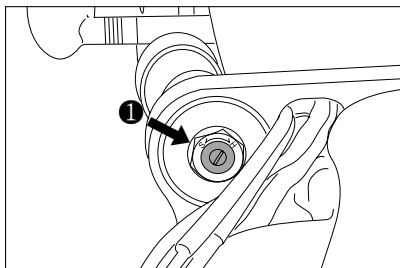

The rebound and compression damping force can be individually adjusted by turning the respective adjusters. The rebound damping force adjuster ① is located at the top of the front fork. The compression damping force adjuster ② is located at the bottom of the front fork.

To adjust the damping force turn the adjuster fully for “S” or “H” direction.

Count the number of clicks from the fully turned-in position.

Fully turned-in “H” direction provides stiffest damping force and turning “S” direction the adjuster will soften damping force.

The rebound and compression damping force is set on “Solo riding standard (refer to below chart)” position at the factory.



WARNING

Be sure to adjust the damping force on both front forks equally. Setting one front fork harder than the other will interfere the stability of the motorcycle.

STANDARD FRONT FORK DAMPING FORCE

| | | Rebound | Compression |
|-------------|----------|--|--|
| Solo riding | Softer | Turn to “S” direction | Turn to “S” direction |
| | Standard | 3 clicks out from end of “H” direction | End of “S” direction |
| | Stiffer | Turn to “H” direction | Turn to “H” direction |
| Dual riding | | 3 clicks out from end of “H” direction | 2 clicks out from end of “S” direction |

FUEL TANK STAY

「Aquila」 have the “fuel tank stay” under the seat.

Use the “fuel tank stay” to inspect the engine or the other parts easily.

◎ USE OF FUEL TANK STAY

1. Place the motorcycle on the side stand.

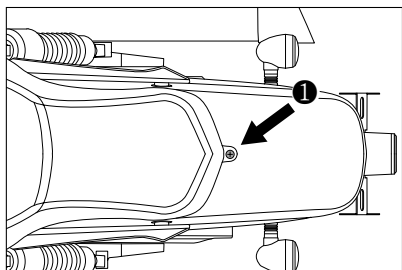

2. Remove the seat by removing the seat mounting bolt (1) on the rearside of the seat.

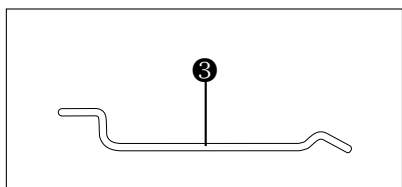
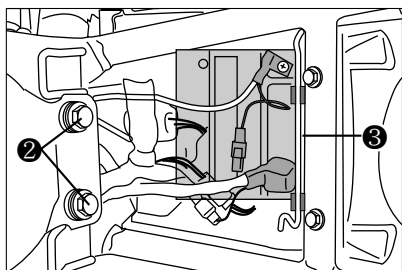

3. Remove the fuel tank mounting bolt (2).
4. Take the fuel tank stay (3) off the tray upper the battery.

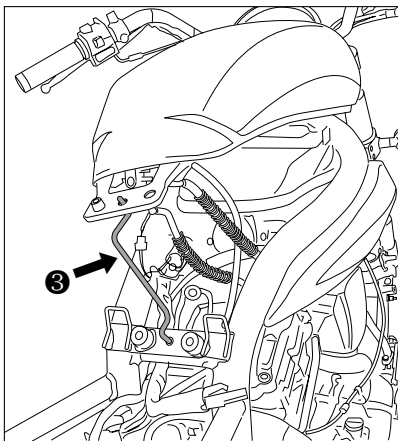

5. Lift the rear end of the fuel tank and prop it up as shown above. Insert the crank end of the fuel tank stay (3) into the hole of the fuel tank and frame.

SUPPLY OF GASOLINE ENGINE OIL AND COOLANT

GASOLINE

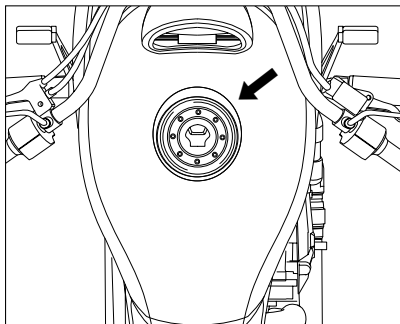

To open the fuel tank cap, insert the ignition key into the lock and turn it clockwise. With the key inserted, lift the cap up with the key.

To close the fuel tank cap, push the cap down firmly with the key in the cap lock.

WARNING

Do not overfill the fuel tank. Stop adding fuel when the fuel level reaches the bottom of the filler neck. If you fill the tank beyond this level, fuel may overflow when it expands due to engine heat or heating by the sun.

WARNING

Gasoline is extremely flammable and toxic. Always observe the following precautions when refueling your

“Aquila”.

- Never permit motorcycle refueling by anyone other than an adult.
- Refuel in a well ventilated area.
- Make sure the engine is off and avoid spilling fuel on a hot engine.
- Do not smoke, and make sure there are no open flames or sparks in the area.
- Avoid prolonged contact with skin and breathing of gasoline vapors.
- Keep children and pets away during refueling.

ENGINE OIL

Long engine life depends much on the selection of quality oil and the periodic changing of the oil.

Daily oil level checks and periodic changes are two of the most important maintenances to be performed.

⊙ ENGINE OIL LEVEL CHECK

Follow the procedure below to inspect the engine oil level.

1. Start the engine and run it for a few minutes.
2. Stop the engine and wait three minutes.
3. Hold the motorcycle vertically and inspect the engine oil level through the engine oil level lens on the right side on the engine.

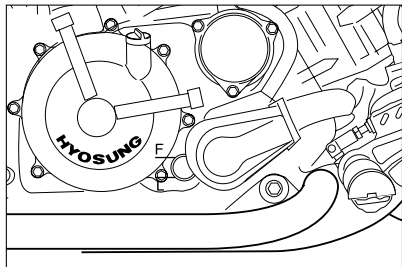

⚠ CAUTION

“Fuel, Engine oil and Coolant” use certainly to recommend at the front part.

⚠ CAUTION

Never operate the motorcycle if the engine oil level is below the “Lower line mark(L)” in the engine oil level lens. Never fill the engine oil above the “Upper line mark(F)”. Engine oil level being most suitable about 1mm under the “Upper line mark(F)” of the engine oil level lens. In case of the engine oil pouring excessively, the engine output being made insufficient.

Be careful not to pour the engine oil excessively.

⊙ ENGINE OIL AND FILTER CHANGE

Change the engine oil and filter, after first running 1,000km and every running 6,000km.

The oil should always be changed when the engine is hot so that the oil will be drained thoroughly from the engine. The procedure is as follows.

ENGINE OIL CAPACITY

| | |
|--------------------|----------|
| Replace | 3,000 ml |
| Oil filter replace | 3,200 ml |
| Overhaul | 3,400 ml |

⚠ CAUTION

In case of the engine oil pouring excessively, the engine output being made insufficient.

Be careful not to pour the engine oil excessively.

1. Place the motorcycle on the jack or block.

⚠ CAUTION

More frequent servicing may be performed on motorcycles that are used under severe conditions, inspect ① Quantity of Engine oil, ② Pollution degree of Engine oil before riding the motorcycle and then supplement and replace at any time to prevent damage of the engine.

2. Place a drain pan under the engine.
3. Remove the engine oil filler cap ①.

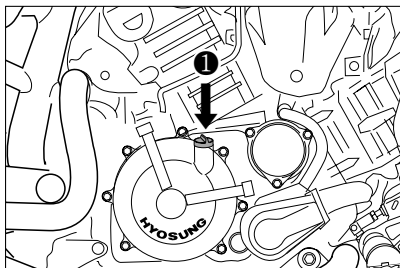

4. Drain the oil by removing the drain plug ② located on the bottom of the engine.

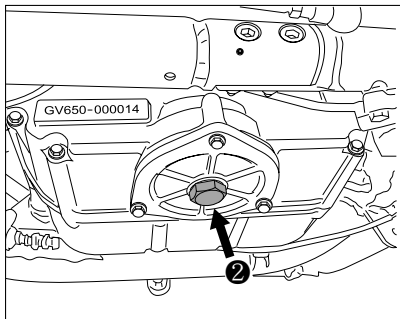

⚠ CAUTION

Necessarily, confirm and clean the oil strainer ① when replace the Engine oil (specially, when first replacement).

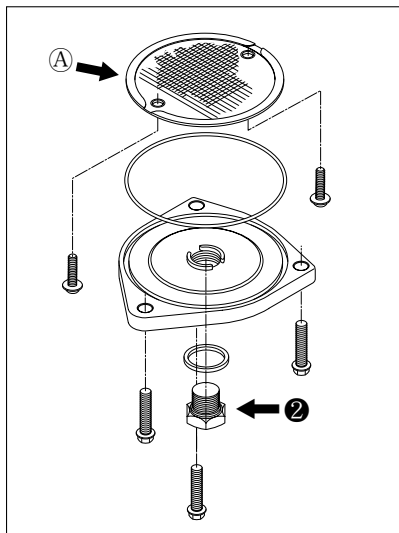

5. Remove the three nuts ③ holding the filter cap ⑥ in place.

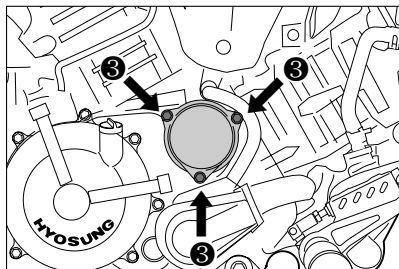

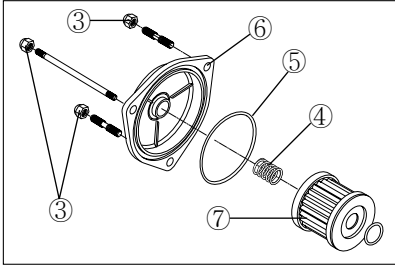

⚠ CAUTION

Insert the filter so that surface of the filter hole turn toward the engine.

● OIL FILTER INSTALLATION

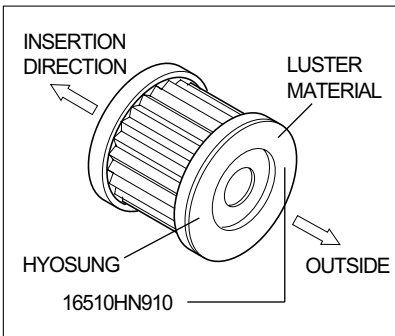

⚠ CAUTION

When install the oil filter, necessarily, “HYOSUNG” character and “16510HN910” part’s NO. install toward the outside, otherwise can damage the engine.

⚠ WARNING

Engine oil and exhaust pipes can be hot enough to burn you.

Wait until the oil drain plug and exhaust pipes are cool enough to touch with bare hands before draining oil.

⚠ WARNING

New and used oil and solvent can be hazardous. Children and pets may be harmed by swallowing new or used engine oil or solvent. Continuous contact with used engine oil has been found to cause skin cancer in laboratory animals. Brief contact with used oil or solvent may irritate skin.

- Keep new and used oil and solvent away from children and pets.
- Wear a long-sleeve shirt and waterproof gloves.
- Wash with soap if oil or solvent contact your skin.

6. Replace the engine oil filter ⑦ with a new one.
7. Before replacing the engine oil filter cap ⑥, be sure to check that the engine oil filter spring ④ and the “O” ring ⑤ are installed correctly. Use new “O” ring each time the engine oil filter element is replaced.
8. Replace the oil filter cap ⑥ and tighten the nuts securely but do not over tighten them.

9. Replace the drain plug and tighten it securely. This time, insert the gasket necessarily. Pour fresh oil through the filler hole. Approximately 3,200ml of oil will be required.

⚠ CAUTION

Approximately 3,000ml of oil must be required when changing oil only without replacing the oil filter.

⚠ CAUTION

In case of the engine oil pouring excessively, the engine output being made insufficient.

Be careful not to pour engine oil.

10. Operate the engine a few seconds by idling speed.
- Inspect the oil leakage at the oil filter cap.
11. Confirm the oil level with the oil level lens after waiting about a minute next to stopping the engine.

The oil level is located between the "Lower line(L)" and the "Upper line(F)".

When below the "Lower line(L)", refill the oil between the "Lower line(L)" and the "Upper line(F)".

COOLANT

⊙ COOLANT LEVEL

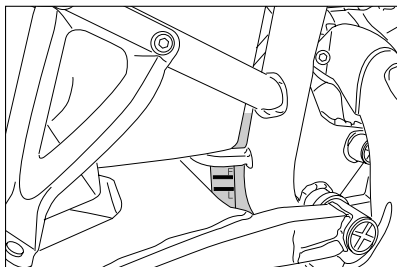

The coolant should be kept between the "F" (FULL) and "L" (LOW) level lines in the reservoir tank at all times. Inspect the level every time before riding while the motorcycle vertically. If the coolant is found lower than the "L" level line, add properly mixed coolant in the following way :

If the reservoir tank is emptied, pour the engine coolant to the reservoir tank and radiator.

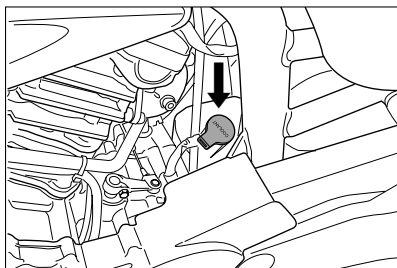

Remove the filler cap and add properly mixed coolant through the filler hole until it reaches the "F" line.

Refer to the FUEL, ENGINE OIL AND COOLANT RECOMMENDATION section (12 page).

WARNING

Engine coolant is harmful or fatal if swallowed or inhaled.

Do not drink anti-freeze or coolant solution. If swallowed, do not induce vomiting. Immediately contact a poison control center or a physician. Avoid inhaling mist or hot vapors ; if inhaled, remove to fresh air.

If coolant gets in eyes, flush eyes with water and seek medical attention. Wash thoroughly after handling. Solution can be poisonous to animals. Keep out of the reach of children and animals.

NOTE

Adding only water will dilute the engine coolant and reduce its effectiveness. Add 50 : 50 mixture of engine coolant and water.

⊙ CHANGING THE COOLANT

Change the coolant every two years.

NOTE

About 1.6 l of coolant will be required when filling the radiator and reservoir tank.

⊙ OPEN THE RADIATOR CAP

Remove the right front side cover ① to operate the radiator cap ③.

To disassemble the right front side cover ①, remove the two mounting bolt ②.

WARNING

You can be injured by scalding fluid or steam if you open the radiator cap when the engine is hot.

After the engine cools, wrap a thick cloth around cap and carefully remove the cap by turning it a quarter to allow pressure to escape and then turn the cap all the way off.

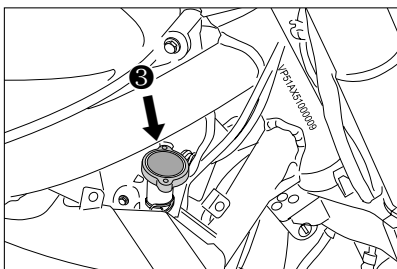
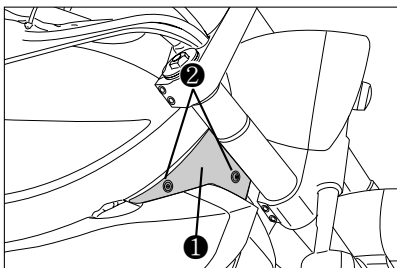

RIDING TIPS

STARTING THE ENGINE

Necessary attempt before start the engine :

1. Inspect every day once before riding the motorcycle.
2. The transmission is in neutral.
3. The ignition switch is in the "ON" position.
4. The engine stop switch is in the "○" position.
5. Moving the side stand to the upper position.
6. Pull the clutch lever.



WARNING

The *Aquila* is equipped with the side stand ignition interlock system.

If the transmission is in neutral or side stand up, you can only start the engine with pulling the clutch lever.

This side stand ignition interlock system prevents the motorcycle from being started with side stand down.

Make sure that the side stand ignition interlock system is working properly before riding.



CAUTION

This motorcycle always come on the head lamp and tail lamp when starting the engine.

⊙ When the engine is cold :

1. Turn the carburetor choke lever all the way toward you.
2. Close the throttle grip and push the starter switch.
3. Immediately after the engine starts, return the choke lever halfway and warm up the engine.
4. Return the choke lever all the way back to its disengaged position.

⊙ When the engine is warm :

1. Open the throttle grip 1/8 ~ 1/4.
2. Push the starter switch.



CAUTION

Operation of the carburetor choke system is not necessary when the engine is warm.



WARNING

Running the engine indoors or in a garage can be hazardous.

Exhaust gas contains carbon monoxide, a gas that is colorless and odorless and can cause death or severe injury.

Only run the engine outdoors where there is a fresh air.



CAUTION

Running the engine too long without riding may cause the engine to overheat.

Overheating can result in damage to internal engine components and discoloration of exhaust pipes.

Shut the engine off if you do not begin your ride promptly.

CAUTION

Do not engage the starting motor for more than five seconds at a time as it may overheat the wiring harness and starting motor.

If the engine does not start after several attempts, check the fuel supply and ignition system. (Refer for Page 67)

STARTING OFF

WARNING

Riding this motorcycle at excessive speed increases your chances of losing control of the motorcycle.

This may result in an accident.

Always ride within the limits of your skills, your motorcycle, and the riding conditions.

WARNING

Removing your hands from the handlebars or feet from the footrests during operation can be hazardous. If you remove even one hand or foot from the motorcycle, you can reduce your ability to control the motorcycle.

Always keep both hands on the handlebars and both feet on the footrests of your motorcycle during operation.

WARNING

Sudden side winds, which can occur when being passed by large vehicles, at tunnel exits or in hilly areas, can upset your control.

Reduce your speed and be alert to side winds.

Pull the clutch lever and pause momentarily. Engage first gear by depressing the gearshift lever downward.

Turn the throttle grip toward you and at the same time release the clutch lever gently and smoothly. As the clutch engages, the motorcycle will start moving forward. To shift to the next higher gear, accelerate gently, then close the throttle and pull the clutch lever simultaneously. Lift the gearshift lever upward to select the next gear and release the clutch lever and open the throttle again.

Select the gears in this manner until fifth gear is reached.



WARNING

Downshifting while the motorcycle is leaned over in a corner may cause rear wheel skid and loss of control.

Reduce your speed and downshift before entering corner.



WARNING

Do not operate the ignition switch of its "OFF" position, the steering lock to lock or the engine stop switch of its "⊗" position while driving at one's pleasure.

USING THE TRANSMISSION

The transmission is provided to keep the engine operating smoothly in its normal operating speed range. The gear ratios have been carefully chosen to meet the characteristics of the engine. The rider should always select the most suitable gear for the prevailing conditions.



WARNING

Downshifting when engine speed is too high can ;

- cause the rear wheel to skid and lose traction due to increased engine braking, resulting in an accident ; or
- force the engine to overrev in the lower gear, resulting in engine damage.

Reduce speed before downshifting.

RIDING ON HILLS

Climbing steep hills, the motorcycle may begin to slow down and show lack of power. At this point you should shift to a lower gear so that the engine will again be operating in its normal power range. Shift gear rapidly to prevent the motorcycle from losing momentum.

When riding down a steep hill, the engine may be used for braking by shifting to a lower gear.

Be careful, however, not to allow the engine to overrev.

STOPPING AND PARKING

1. Turn the throttle grip away from you to close the throttle completely.
2. Apply the front and rear brakes evenly at the same time.
3. Downshift through the gears as road speed decreases.
4. Select neutral with the clutch lever squeezed towards the grip (disengaged position) just before the motorcycle stops. Neutral position can be confirmed by observing the neutral indicator lamp.

WARNING

Inexperienced riders tend to underutilize the front brake. This can cause excessive stopping distance and lead to a collision. Using only the front or rear brake can cause skidding and loss of control.

Apply both brakes evenly at the same time.

WARNING

Hard braking while turning may cause wheel skid and loss of control.

Brake before you begin to turn.

WARNING

Hard braking on wet, loose, rough, or other slippery surfaces can cause wheel skid and loss of control.

Brake lightly and carefully on slippery or irregular surfaces.



WARNING

Following another vehicle too closely can lead to a collision. As vehicle speeds increase, stopping distance increases progressively.

Be sure you have a safe stopping distance between you and the vehicle in front of you.

5. Park the motorcycle on a firm, flat surface where it will not fall over.



WARNING

A hot muffler can burn you. The muffler will be hot enough to burn you for some time after stopping the engine.

Park the motorcycle where pedestrians or children are not likely to touch the muffler.

6. Turn the ignition switch to the OFF position and remove ignition key.
7. Turn the handlebar all the way to the left.
8. Insert the ignition key into the steering lock, and take a turn it from the ● position.
9. Remove the ignition key.

BREAK-IN

This section explains how important proper break-in is to achieve maximum life and performance from your new **Hyosung**. The following guidelines explain proper break-in procedures.

★ MAXIMUM THROTTLE OPENING RECOMMENDATIONS

The table below shows the maximum throttle opening recommendation during the break-in period.

| | |
|----------------------------|------------------------|
| Initial 800km (500miles) | Less than 1/2 throttle |
| Up to 1,600km (1,000miles) | Less than 3/4 throttle |

★ AVOID CONSTANT LOW SPEED

Operating the engine at constant low speed(light load) can cause parts to glaze and not seat in. Allow the engine to accelerate freely through the gears, without exceeding the recommended maximum limits. Do not, however, use full throttle for the first 1,600km(1,000 miles).

★ VARY THE ENGINE SPEED

The engine speed should be varied and not held at a constant speed.

This allows the parts to be "loaded" with pressure and then unloaded, allowing the parts to cool.

This aids the mating process of the parts. It is essential that some stress be placed on the engine components during break-in to ensure this mating process.

Do not apply excessive load on the engine.

★ BREAKING IN THE NEW TIRES

New tires need proper break-in to assure maximum performance, just as the engine does.

Wear in the tread surface by gradually increasing your cornering lean angles over the first 160km(100miles) before attempting maximum performance. Avoid hard acceleration, hard cornering, and hard braking for the first 160km(100miles).



WARNING

Failure to perform break-in of the tires could cause tire slip and loss of control. Use extra care when riding on new tire. Perform proper break-in of the tire as described in this section and avoid hard acceleration, hard cornering, and hard braking for the first 160km(100miles).

★ ALLOW THE ENGINE OIL TO CIRCULATE BEFORE RIDING

Allow sufficient idling time after warm or cold engine start up before applying load or revving the engine. This allows time for the lubricating oil to reach all critical engine components.

★ OBSERVE YOUR FIRST, AND MOST 1,000km SERVICE

The 1,000km (600miles) service is the most important service your motorcycle will receive.

During break-in procedures, all of the engine components will have worn in and all of the other parts will have seated in.

All adjustments will be restored, all fasteners will be tightened, and the dirty engine oil and engine oil filter will be replaced.

Timely performance of the 1,000km (600miles) service will ensure optimum service life and performance from the engine.

CAUTION

Service should may be performed before 1,000km(600miles) on motorcycle that are used under severe conditions.

CAUTION

The 1,000km (600miles) service should be performed as outlined in the INSPECTION AND MAINTENANCE section of this Owner' s Manual. Pay particular attention to the 『CAUTION』 and 『WARNING』 in that section.

INSPECTION BEFORE RIDING

Before riding the motorcycle, be sure to check the following item.

Inspect every day once them before riding motorcycle.

| WHAT TO CHECK | CHECK FOR : |
|--|--|
| Steering | <ul style="list-style-type: none"> • Smoothness • No restriction of movement • No play or looseness |
| Throttle | <ul style="list-style-type: none"> • Correct play in the throttle cable • Smooth operation and positive return of the throttle grip to the closed position |
| Clutch | <ul style="list-style-type: none"> • Correct lever play • Smooth and progressive action |
| Brakes | <ul style="list-style-type: none"> • Fluid level in the reservoir to be above "LOWER" line • Correct pedal and lever play • No "sponginess" • No fluid leakage • Brake pads not to be worn down to the limit line |
| Suspension | Smooth movement |
| Fuel | Enough fuel for the planned distance of operation |
| Drive belt | <ul style="list-style-type: none"> • Correct tension or slack • No excessive wear or damage |
| Tires | <ul style="list-style-type: none"> • Correct pressure • Adequate tread depth • No cracks or cuts |
| Engine oil | Correct level and pollution degree of engine oil |
| Cooling system | <ul style="list-style-type: none"> • Proper coolant level • No coolant leakage |
| Lighting | Operation of all lights and indicators |
| Horn | Correct function |
| Engine stop switch | Correct function |
| Side stand / Ignition interlock switch | Proper operation |

PERIODIC MAINTENANCE

The chart indicates the intervals between periodic service in kilometers.

At the end of each interval, be sure to inspect, check, lubricate and service as instructed.

If your motorcycle is used under high stress conditions such as continuous full throttle operation, or is operated in a dusty climate, certain services should be performed more often to ensure reliability of the machine as explained in the maintenance section.

Your **Hyosung** dealer can provide you with further guide lines.

Steering components, suspensions require very special and careful servicing. For maximum safety we suggest that you have these items inspected and serviced by your authorized **Hyosung** dealer or a qualified service mechanic.

● LUBRICATION POINTS

Proper lubrication is important for smooth and long life of each working part of your motorcycle and also for safe riding. It is a good practice to lubricate the motorcycle after a long rough ride or after it gets wet in the rain or after washing it.

Major lubrication points are indicated as follows.



WARNING

Improper maintenance or failure to perform recommended maintenance increases the chance of an accident or motorcycle damage.



CAUTION

**Using poor quality replacement parts can cause your motorcycle to wear more quickly and may shorten its useful life.
Use only genuine Hyosung replacement parts or their equivalent.**

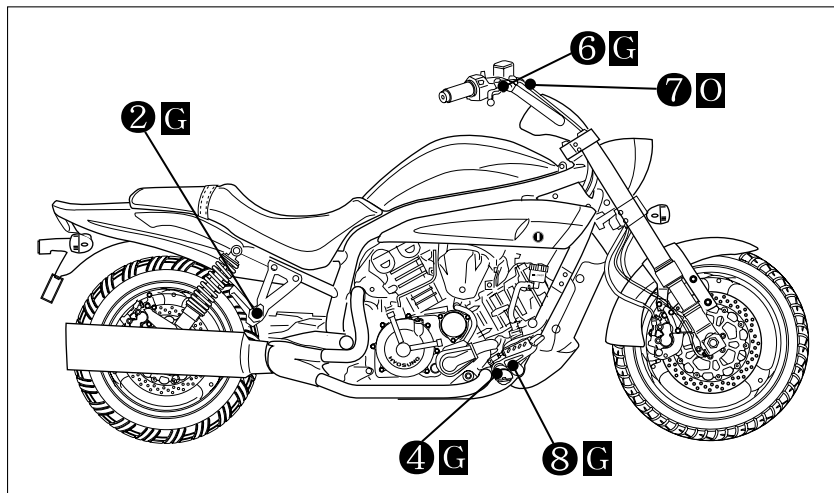
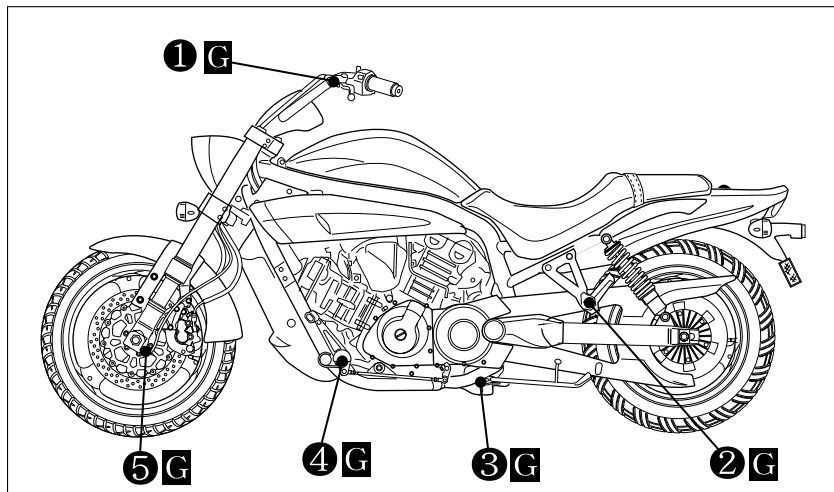

- ① Clutch lever holder and clutch cable
- ② Passenger footrests pivot
- ③ Side stand pivot and spring hook
- ④ Footrests pivot

- ⑤ Speedometer gear box
- ⑥ Front brake lever holder
- ⑦ Throttle cable
- ⑧ Rear brake pedal pivot

⓪ - Motor oil Ⓜ - Grease

● ENGINE

| Item \ Interval | First 1,000 km | Every 6,000 km | Every 12,000 km |
|---|--|-------------------|--------------------|
| Air cleaner element | Clean every 3,000 km · Replace every 12,000 km | | |
| Exhaust pipe bolts and muffler mounting bolts ★ | Tighten | Tighten | — |
| Valve clearance adjust ★ | Inspect | Inspect | — |
| Cylinder head bolt ★ | Tighten | Tighten | — |
| Cylinder head & Cylinder ★ | — | — | Remove carbon |
| Spark plug | Clean | Clean | Replace |
| Fuel hose | Inspect | Inspect | — |
| | Replace every 4 years | | |
| Engine oil filter | Replace | Replace | — |
| Engine oil | Replace | Replace | — |
| Throttle cable | Inspect | Inspect | — |
| Idle speed ★ | Inspect | Inspect | — |
| Clutch ★ | Inspect | Inspect | — |
| Engine coolant ★ | Replace every 2 years | | |
| Radiator hose ★ | — | Inspect | — |
| | Replace every 4 years | | |

● CHASSIS

| Item \ Interval | First 1,000 km | Every 6,000 km | Every 12,000 km |
|--------------------------|------------------------|-------------------|--------------------|
| Drive belt ★ | Inspect every 1,000 km | | |
| Brake ★ | Inspect | Inspect | — |
| Brake hose ★ | Inspect | Inspect | — |
| | Replace every 4 years | | |
| Brake fluid ★ | Inspect | Inspect | — |
| | Replace every 2 years | | |
| Tire | Inspect | Inspect | — |
| Steering ★ | Inspect | Inspect | — |
| Front forks ★ | — | Inspect | — |
| Rear shock absorber ★ | — | Inspect | — |
| Chassis nuts and bolts ★ | Tighten | Tighten | — |

NOTE

★ = Ask your Hyosung dealer or qualified mechanic to do the maintenance items marked.

INSPECTION AND MAINTENANCE

TOOL

To assist you in the performance of periodic maintenance, a tool kit is supplied and is located under the seat. The tool kit consists of the following items.

| NO. | NAME |
|-----|-----------------------------|
| 1 | Tool bag |
| 2 | 10 × 12 mm open end spanner |
| 3 | 14 × 17 mm open end spanner |
| 4 | Spark plug wrench |
| 5 | Combination screw driver |
| 6 | Screw driver handle |
| 7 | Pliers |
| 8 | Hexagon wrench 4 mm |
| 9 | Hexagon wrench 6 mm |

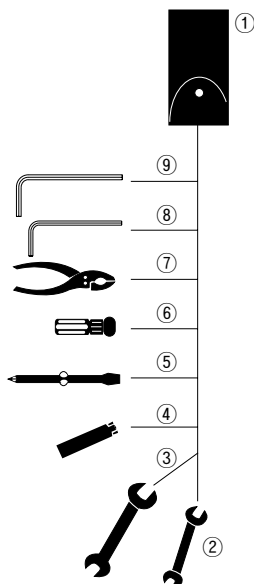

ENGINE OIL

Check if there is leakage from crankcase.

GASOLINE

Check if there is leakage from fuel tank, fuel pump, fuel cock, hose, carburetor.

FUEL HOSE

Inspect the fuel hose for damage and fuel leakage. If any defect are found the fuel hose must be replaced.

Replace the fuel hose every 4 years.

COOLANT

Check if there is leakage from the radiator, coolant hose.

RADIATOR

Check if there is damage from the radiator.

RUBBER CAP OF CABLES

Mop them up with a patch when washing.

EXHAUST PIPE AND MUFFLER

Inspect the exhaust pipe and muffler joint for loosening.

FRONT FORK

- Check if there is any noise by bend of front fork while moving the handle upward and downward.
- Inspect whether the steering stem is well assembled while moving front fork up/downwards and /or forward/backward.

REAR SHOCK ABSORBER

Inspect the rear shock absorber for oil leakage and spring condition.

BATTERY

● INSPECTION OF BATTERY SOLUTION LEVEL

MF(Maintenance Free) battery of airtight type is used for this motorcycle.

It is not necessary to inspect or supplement battery fluid.

The battery is located under the seat.

However, have your dealer check the charging condition of battery periodically.

CAUTION

- Do not remove absolutely airtight cover as airtight type battery.
- Keep after separate at the motorcycle for the minimum of self electric discharge and electric leakage when don't use for a long time.
- Remove the (-) negative terminal when keep intact at the motorcycle.

⊙ CLEAN OF BATTERY TERMINAL

Clean the battery terminal when it is dusty or rusted.

1. Set the ignition switch "OFF" position.
2. Disassemble the seat, disassemble the (+) positive battery wire after the (-) negative battery wire.
Remove the battery.
3. Clean the terminal.
If there is white dust, clean it with warm water.
4. Assemble the battery wires and grease the terminal lightly.

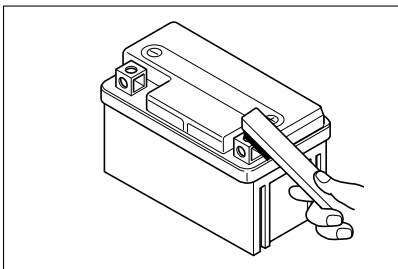

⚠ CAUTION

- Keep the battery away from fires.
- When disassemble the battery wire, take off ⊖ terminal first with the ignition switch "OFF" position. When assemble, ⊕ terminal first.
- Fasten certainly the battery wires.
- Incorrect installation of the battery will reverse the terminal position resulting in possible electrical system damage due to incorrect battery lead connection.
- Never charge a battery while still in the machine as damage may result to the battery or regulator/rectifier.

AIR CLEANER

If the air cleaner element has become clogged with dust, intake resistance will increase with a resultant decrease in power output and an increase in fuel consumption. If riding under severe conditions must be cleaned or replaced more frequently than maintenance schedule. Check and clean the air cleaner element periodically according to the following procedure.

⚠ CAUTION

If the air cleaner element is polluted, will occur to starting go out, output insufficiency, combustion efficiency decline, and sooty smoke(black smoke). This appearance is occurred at first to clean the air cleaner element and confirm.

1. The air cleaner is located under the fuel tank.
Remove the fuel tank.
2. Remove the four screw ①.
3. Pull up the air cleaner inlet guide ②, and the air cleaner element ③.

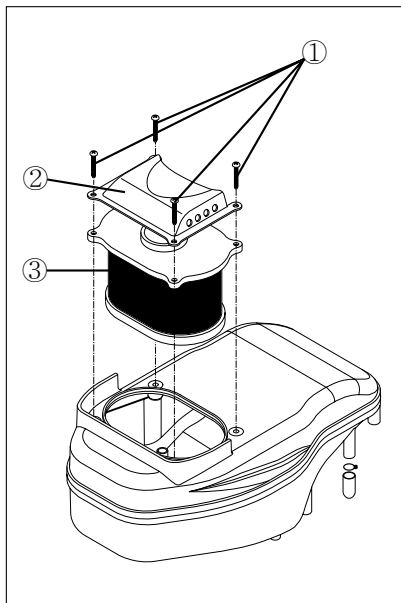

4. Clean the air cleaner element for the following :

- 1) When the air cleaner element clean with the air gun, necessarily blow at the inside by compressed air.
- 2) Carefully examine the air cleaner element for tears during cleaning. Replace it with a new one if it is torn.
- 3) Assemble the element completely or damage severely the engine.
- 4) Be careful not to allow water to go inside the air cleaner element.

⚠ CAUTION

- Assemble the element completely or damage severely the engine.
- Be careful not to allow water to go inside the air cleaner element.

⚠ CAUTION

Before and during the cleaning operation, inspect the element for tears. A torn element must be replaced.

Be sure to put the element snugly and correctly, so that no incoming air will bypass it.

Remember, rapid wear of piston rings and cylinder bore is often caused by a defective or poorly fitted element.

⚠ CAUTION

- When the assembly of air cleaner element is not completely done, dusts can go inside and damage severely engine.
- Be careful not to allow water to go into the element while washing.

⚠ CAUTION

More frequent servicing may be performed on motorcycles that are used under severe conditions, also clean the air cleaner element when replacing the oil to prevent damage of the engine.

● AIR CLEANER OIL DRAIN PLUG

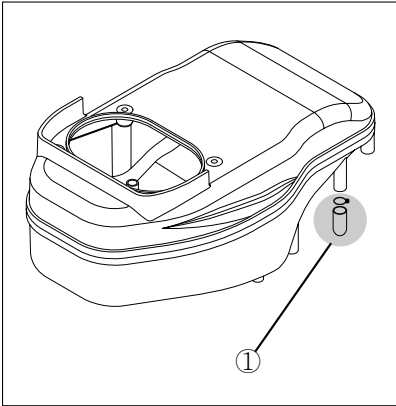

Inspect the plug ① and drain water and oil at the periodic maintenance interval.

The air cleaner oil drain plug ① is located beneath the air cleaner case.

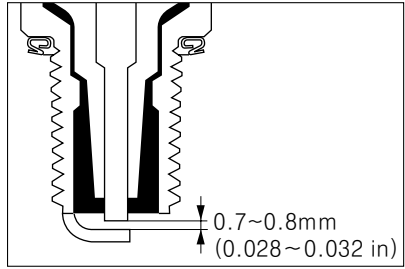

Readjust the spark plug gap to 0.7~0.8mm (0.028 ~ 0.032 in) by using a spark plug gap thickness gauge.

PLUG REPLACEMENT GUIDE

| | |
|---------------|------|
| Hotter type | CR7E |
| Standard type | CR8E |
| Colder type | CR9E |

SPARK PLUG

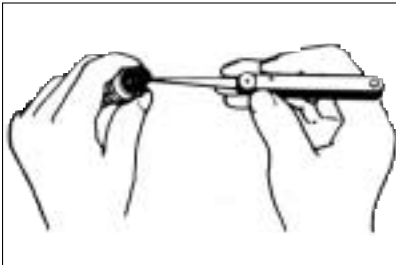

Remove the carbon deposits periodically from the spark plug with a piece of hard wire or pin.

▲ CAUTION

- Do not over torque or cross thread the spark plug or the aluminum threads of the cylinder head will be damaged.

Do not allow contaminants to enter the engine through the spark plug holes when the plug is removed.

- The standard spark plug for this motorcycle has been carefully selected to meet the vast majority of all operational ranges. If the spark plug color indicates that other than a standard spark plug be used, it is best to consult your Hyosung dealer before selecting an alternate plug or heat range. The selection of an improper spark plug can lead to severe engine damage.

CARBURETOR

『Aquila』 is equipped with one set of composed the two carburetors for efficiency increase of the two cylinder.

The carburetor is factory setting for the best carburetion.

Do not attempt to alter its setting.

There are no carburetor adjustments that you can make.

This is not adjustable.

There are two items of adjustment, however, under your care : engine idle speed and throttle cable play.

● IDLING SPEED

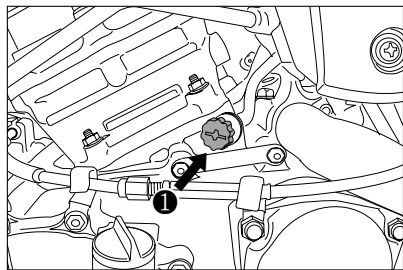

Start up the engine and let the engine run until it warms up fully.

After engine has warmed up, turn the throttle stop screw ① in or out so that the engine may run at 1,300~1,500 RPM.

⚠ CAUTION

The engine idle speed should be adjusted with the engine fully warm.

● THROTTLE CABLE ADJUSTMENT

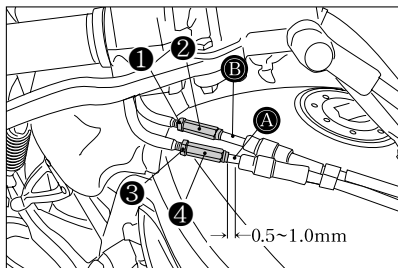

This motorcycle has a twin throttle cable system. Cable ① is for throttle cable and cable ② is for returning cable.

To adjust the cable play :

1. Loosen the lock nut ①.
2. Turn in the adjuster ② fully.
3. Loosen the lock nut ③.
4. Turn the adjuster ④ so that the throttle cable has 0.5~1.0mm (0.02~0.04 in) play.
5. Tighten the lock nut ③ holding the adjuster ④.
6. Holding the throttle grip at the closed position turn out the adjuster ② to feel resistance.
7. Tighten the lock nut ① holding the adjuster ②.

WARNING

Inadequate throttle cable play can cause engine speed to rise suddenly when you turn the throttle grip. This can lead to loss of rider control.

Adjust the throttle cable play so that engine idle speed does not rise due to throttle grip movement.

CAUTION

After completing throttle cable adjustment, check that throttle grip movement does not raise the engine idle speed and that the throttle grip return smoothly and automatically.

CLUTCH ADJUSTMENT

At each maintenance interval, adjust the clutch cable play by means of clutch cable adjuster.

The cable play should be 2mm(0.08in) as measured at the clutch lever holder before the clutch begins to disengage.

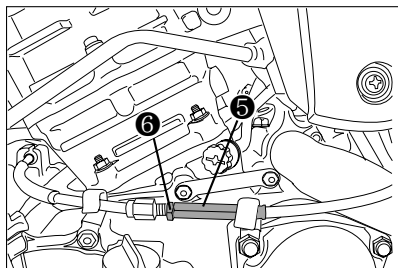
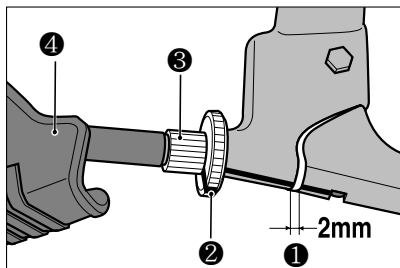

- ① The clutch lever play
- ② The lock nut
- ③ The clutch lever adjuster
- ④ The rubber boot
- ⑤ The cable adjuster
- ⑥ The clutch cable adjuster lock nut

If you find the play of the clutch incorrect, adjust it in the following way :

● CLUTCH CABLE ADJUSTMENT

- A basis adjustment be allowed by the clutch lever adjuster ③.
- Loosen the clutch lever adjuster ③.
- Screw the lock nut ② clockwise fully, finishing adjustment.
- After end of adjustment, tighten the lock nut ② and cover the rubber boot ④.
- If not adjust by the adjuster ③, loosen the clutch cable adjuster lock nut ⑥.
- Turn the clutch cable adjuster ⑤ in or out to acquire the specified play.
- After end of adjustment, tighten the lock nut ⑥.
- The clutch cable should be lubricated with a light weight oil whenever it is adjusted.

Clutch cable play ① 2 mm (0.08 in)

DRIVE BELT

The belt may require more frequent adjustment that it is with periodic maintenance depending upon your riding conditions.

Check the belt every 1,000km.



WARNING

Riding with the belt in poor or improperly adjusted condition can lead to an accident.

Inspect, adjust, and maintain the belt properly before each ride, according to this section.

● INSPECTING THE DRIVE BELT

When inspecting the belt, look for the following :

- Edges of the belt for cuts or unusual wear patterns
- Outside ribbed surface of the belt for sign of stone puncture
- Roots of the belt teeth
- Sign of cracking at the base of the belt teeth
- Common types of belt wear and damage
- Improper belt adjustment

If you find something wrong with the drive belt condition or adjustment, correct the problem if you know how. If necessary, consult your authorized **Hyosung** dealer.

Damage to the drive belt means that the pulleys may also be damaged. Inspect the pulleys for the following :

- Excessively worn teeth

- Broken or damaged teeth
- Loose pulleys mounting nuts

If you find any of these problems with your pulley, consult your **Hyosung** dealer.

⚠ CAUTION

The two pulleys should be inspected for wear when a new belt is installed and replace them if necessary.

● DRIVE BELT SLACK ADJUSTMENT

Adjust the drive belt slack to the proper specification. The belt may require more frequent adjustments than periodic maintenance schedule depending upon your riding conditions.

Adjust the belt in the following way.

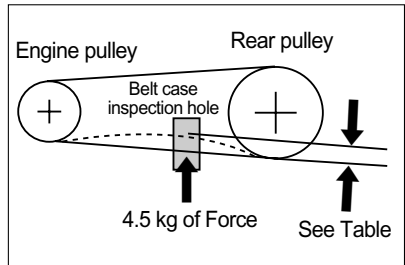
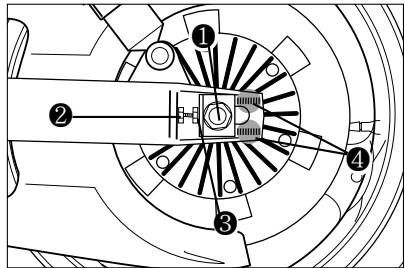

1. Place the motorcycle on the jack or block.
2. Loosen the axle bolt ①.
3. Loosen the lock nut ②.
4. Adjust the slack in the drive belt by adjuster ③ as turning toward the left and right.
5. For alignment of the rear pulley and the engine pulley, there are reference mark ④ on the same position, right and left. Aligning and adjusting the slack in the drive belt to specification, retighten the lock nut and axle bolt securely and perform a final inspection.

DRIVE BELT SLACK (4.5kg of Force)

| | |
|--|----------------------------------|
| When the rear tire be touched the ground | 4.5 ~ 5.5 mm (0.18 ~ 0.22 in) |
| When the rear tire be not touched the ground | 5.0 ~ 6.0 mm (0.20 ~ 0.24 in) |

⚠ CAUTION

The drive belt for this motorcycle is made of the special material. The belt should be replaced with a poly chain belt for 『Aquila』. Use of another belt may lead to premature belt failure.

⚠ CAUTION

The drive belt should be inspected every time before riding. Excessive belt slack could cause the belt to come off the pulleys and result in accident or serious engine damage.

⚠ WARNING

Be careful not to touch the muffler when it is hot : a hot muffler can burn you.

⊙ CAUTION OF DRIVE BELT

When the drive belt was bent excessively, the belt inner cord is broken.

Never bend the drive belt under the specification of inner or back bend capacity.

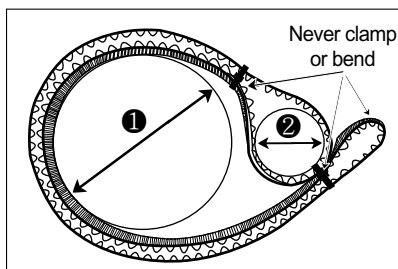

※ ① Back bend ② Inner bend

BEND CAPACITY OF DRIVE BELT

| | |
|-------|------------------------|
| Inner | least 102 mm (4.02 in) |
| Back | least 204 mm (8.04 in) |

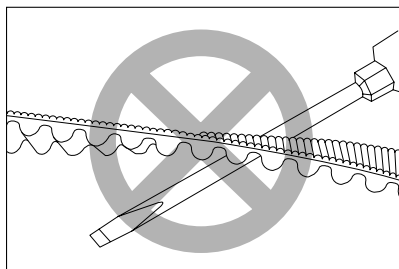

⚠ CAUTION

- Never bend or twist when the drive belt is kept or installed.
- If the drive belt was installed with driver forcedly, damage the drive belt.

BRAKES

「Aquila」 utilizes front and rear disk brakes.

The proper operation the brake systems is vital to safe riding. Be sure to perform the brake inspection requirements as schedules.

The brakes should be inspected at periodic inspection by your authorized Hyosung dealer.

⦿ BRAKE FLUID

Be sure to check the brake fluid level in the master cylinder. If the level was found to be lower than the lower mark holding the motorcycle upright, replenish with the proper brake fluid that meets Hyosung's requirements.

As the brake pads wear, the fluid level will drop to compensate for the new position of brake pads.

Replenishing the master cylinder to considered normal periodic maintenance.

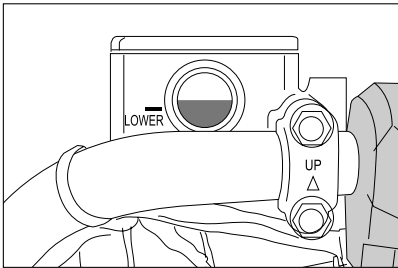

[Front Brake]

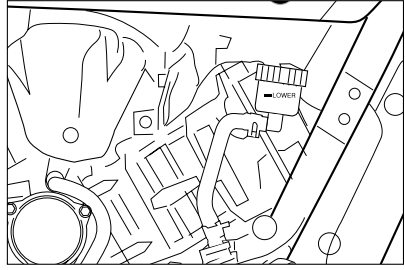

[Rear Brake]



WARNING

Brake fluid may be harmful if swallowed or if it comes in contact with skin or eyes. Contact your doctor immediately if brake fluid is swallowed and induce vomiting. If brake fluid gets into the eyes or in contact with the skin, flush thoroughly with plenty of water.



CAUTION

This motorcycle uses glycol-based brake fluid.

Do not use or mix different types of brake fluid, otherwise serious damage will result in the brake system.

Use DOT3 or DOT4 brake fluid for front, and DOT4 brake fluid for rear.

Do not spill any brake fluid on painted or plastic surfaces as it will damage the surface severely.

Never use any brake fluid that has been stored in a used or unsealed container. Never reuse brake fluid left over from the last servicing and stored for long period as it absorbs moisture from the air.

⦿ BRAKE PADS

Inspect the front brake pads by nothing whether or not the friction pads are worn down to the grooved limit line. If a pad is worn to the grooved limit line it must be replaced with a new one by your authorized Hyosung dealer or qualified service mechanic.

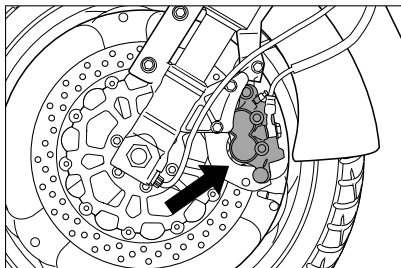

[Front Brake]

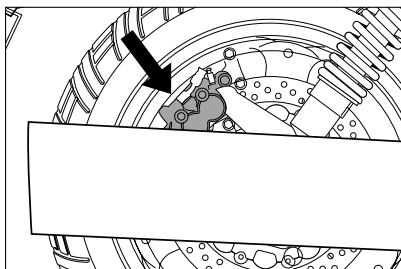

[Rear Brake]

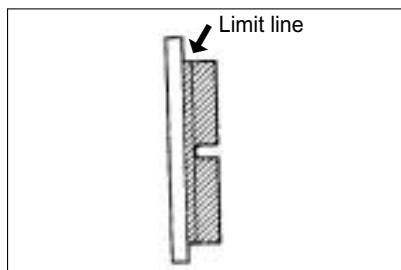

Inspect every day in the following point at the brake system.

- ① Brake fluid leakage of the front and rear brake system.
- ② Leak or damage of the brake hose.
- ③ Operating of the brake lever and pedal.
- ④ Wear of the front and rear brake pads.

⚠ CAUTION

The front and rear brake system be replaced the brake hose or the brake fluid according to periodic inspection chart by your authorized Hyosung dealer for safety as in times of operating at high pressure.

⚠ WARNING

Riding with worn brake pads will reduce braking performance and will increase your chance of having accident. Inspect brake pad wear before each use. Ask your Hyosung dealer or qualified mechanic to replace brake pads if any pad is worn to the limit.

⚠ CAUTION

After replaced the front or rear brake pads, the brake lever and pedal pull and release several times so that it is setting at the original place.

Then, do not ride the motorcycle until operating the brake fluid and becoming the brake distance.

⦿ BRAKE DISK INSPECTION.

Check the brake disk for damage or cracks.

⦿ FRONT BRAKE FLUID SUPPLY

1. Place the motorcycle on a level surface and keep the handlebars straight.
2. Clean the brake fluid reservoir around not to allow dust to get inside of it.
3. Loosen the screw and open the cap.
4. Replenish with brake fluid to the upper line.

CAUTION

Do not spill any brake fluid on painted or plastic surfaces as it will damage the surface severely.

N O T E

The recommended brake fluid
: DOT3 or DOT4

5. Fasten the cap.

⦿ REAR BRAKE FLUID SUPPLY

1. Place the motorcycle on a level surface and keep the handlebars straight.
2. Clean the brake fluid reservoir around not to allow dust to get inside of it.
3. Turn the cap to the counter - clockwise.
4. Replenish with brake fluid to the upper line.

N O T E

The recommended brake fluid : DOT4

5. Fasten the cap.

⦿ FRONT BRAKE LAMP SWITCH

The front brake lamp switch is located beneath the front brake lever. Loosen the switch fitting screws and adjust the timing by moving the switch body forward or backward.

⦿ REAL BRAKE LAMP SWITCH

The rear brake lamp switch is located inside the rear brake pedal.

Move the switch up or down to adjust it until the switch operates and turns on the brake lamp after the brake pedal begins to be depressed.

TIRE

Inspect the tire pressure and the tire thread depth periodically.

Inspect frequently the tire pressure for the safety and the tire life.



WARNING

Failure to follow these warnings may result in an accident due to tire failure. The tires on your motorcycle form the crucial link between your motorcycle and the road.

Follow these instructions ;

- Check tire condition and pressure, and adjust pressure before each ride.
- Avoid overloading your motorcycle.
- Replace a tire when worn to the specified limit, or if you find damage such as cuts or cracks.
- Always use the size and type of tires specified in this owner's manual.

| TIRE PRESSURE (COLD INFLATION) | NORMAL RIDING | |
|-----------------------------------|-------------------------|-------------------------|
| | SOLO RIDING | DUAL RIDING |
| FRONT | 2.25 kg/cm ² | 2.25 kg/cm ² |
| | 221 kpa | 221 kpa |
| | 33.0 psi | 33.0 psi |
| REAR | 2.50 kg/cm ² | 2.90 kg/cm ² |
| | 245 kpa | 285 kpa |
| | 36.0 psi | 42.0 psi |

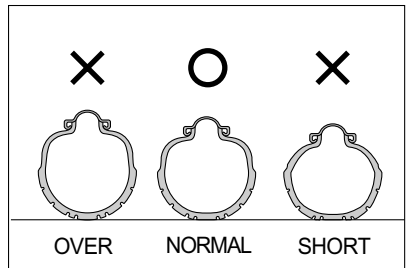

CAUTION

If there are some problem with the tire pressure or cracks and cuts, it will decrease the riding stability and lead to flat tire.

● TIRE PRESSURE

Insufficient air pressure in the tires not only hasten tire wear but also seriously affects the stability of the motorcycle.

Under-inflated tires make smooth cornering difficult and over-inflated tires decrease the amount of tire in contact with the ground which can lead to skids and loss of control. Be sure that the tire pressure is within the specified limits at all times.

Tire pressure should only be adjusted when the tire is cold.

If you see the problem with the tire, adjust the pressure with the pressure gauge.

● CRACKS AND CUTS

Check if

- 1) there are visible cracks and cuts.
- 2) there are pebbles stuck.

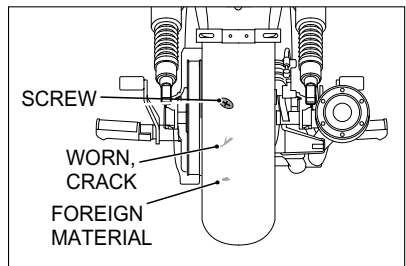

● TIRE TREAD CONDITION

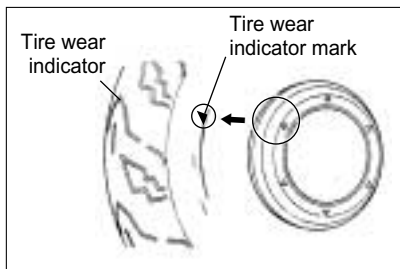

Operating the motorcycle with excessively worn tire will decrease riding stability and can lead to loss of control.

Inspect storage of tire thread's depth by the 『tire wear indicator』.

Replace the front and rear tires at once when appear the 『tire wear indicator』.

▲ CAUTION

The standard tire on 『Aquila』 is 120/70-ZR 18 59W for front, and 180/55-ZR 17 73W for rear.

The use of a tire other than standard may cause trouble.
It is highly recommended to use the standard tire supplied by Hyosung.

● REAR AXLE NUT

Inspect the rear axle shaft and jointing nut for loosening.

● TIRE REPLACEMENT

● FRONT TIRE REPLACEMENT

1. Place the motorcycle on the jack or block.

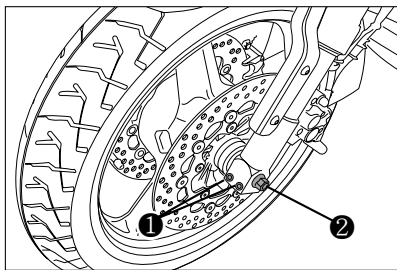

2. Loosen the four front axle pinch bolt ① (right and left).
3. Loosen the front axle ②.
4. Carefully position a jack or block under engine and raise until the front wheel is slightly off the ground.

▲ CAUTION

Improper jacking may cause damage to the oil filter.
Do not apply the jack head to the oil filter jacking up the motorcycle.

5. Draw out the axle shaft.
6. Slide the front wheel forward.
7. To reinstall the wheel assembly, reverse the sequence as described.

● REAR TIRE REPLACEMENT

1. Place the motorcycle on the jack or block.

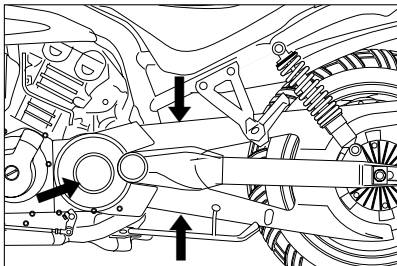

2. Remove the mounting bolts, engine pulley cover and drive belt case.

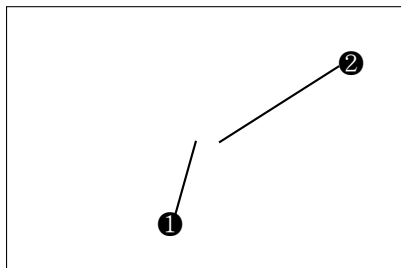

WARNING

**A hot muffler can burn you.
The muffler will be hot enough to burn you for some time after stopping the engine.
Wait until the muffler cools to avoid burns.**

3. Loosen the drive belt adjuster ①, left and right, and disengage the drive belt from the rear pulley.
4. Loosen the rear axle bolt ②.
5. Draw out the rear axle shaft.
6. Pull the rear wheel assembly rearward.
7. To replace the wheel, reverse the complete sequence listed.

REPLACEMENT OF THE LAMP

Requirement electric power of the lamp shown in the following chart.

When replace the damaged lamp, always use the equal capacity.

The use of a lamp other than specification may cause the electric system or the lamp to damage.

| NAMES | | CAPACITY |
|--------------------|----|-------------|
| Head lamp | HI | 12V-60W × 1 |
| | LO | 12V-55W × 1 |
| Brake / Tail lamp | | LED type |
| Turn signal lamp | | 12V-10W × 4 |
| License plate lamp | | 12V-5W × 1 |

※ LED(Light Emitting Diode)

◉ HEAD LAMP

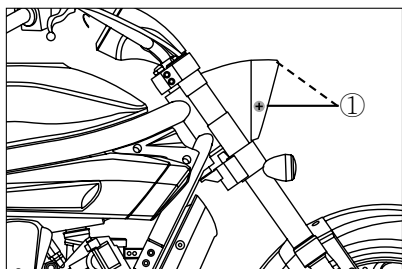

1. Remove the three screw ① (right, left and upside) and the headlamp assembly.

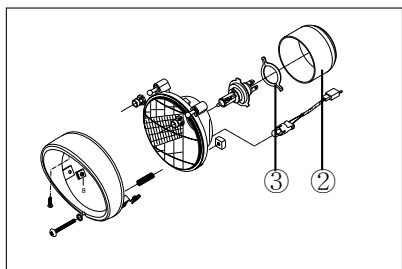

2. Disconnect the headlamp coupler.
3. Remove the dust cover ② and socket spring ③.
4. After removing the bulb at the socket, replace the new bulb.
5. To install the headlamp, reverse the above sequence.

▲ CAUTION

The use of a lamp other than specification may cause to occur the vehicle fire and to damage electric parts.
Surely use the only lamp of proper capacity.

◉ TURN SIGNAL LAMP

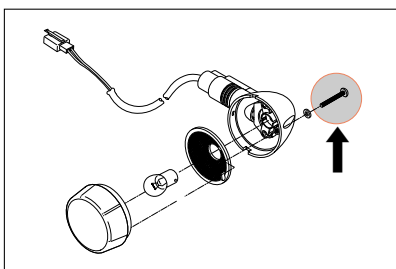

1. Remove the lens by removing the screw.
2. Push the bulb, turn it to the counter-clockwise, and pull it out.
3. After stick in the new lamp, assemble the lens.

▲ CAUTION

Overtightening the screws may cause the lens to crack.

◉ TAIL / BRAKE LAMP

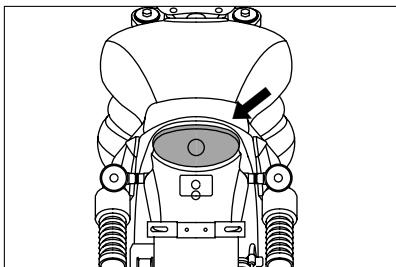

「Aquila」s the tail/brake lamp is LED(Light Emitting Diode) type.
If any abnormal condition are found, replace the tail/brake lamp assembly.

● LICENSE PLATE LAMP

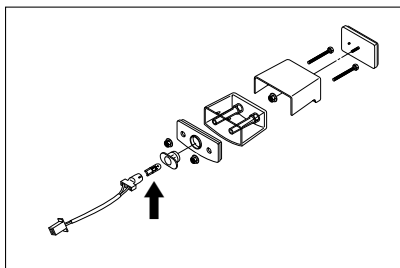

1. Remove the socket under the rear fender.
2. Push the bulb, turn it to the counter-clockwise, and pull it out.
3. To fit the replacement of bulb, push it in and turn it of to the clockwise while pushing.

▲ CAUTION

Overtightening the screws may cause the lens to crack.

● FUSE

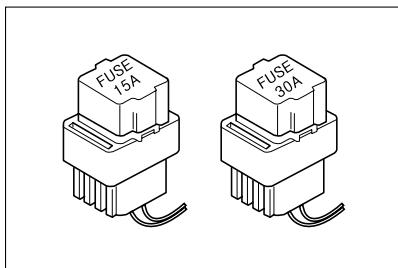
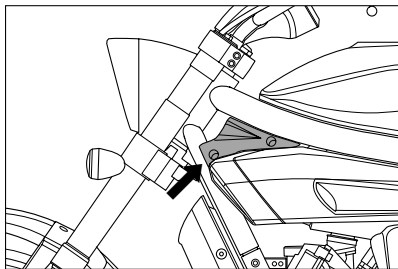

The fuse box is located inside the left front cover. If the engine suddenly stops running or any electrical system fails to operate then the fuse must be checked.

In case a fuse blows there is a 30A for main and 15A for head lamp spare fuse.

- 30A main fuse protects all electrical circuits.
- 15A head lamp fuse protects the head lamp and high beam indicator lamp.

▲ CAUTION

Never use other than specified 30A or 15A fuse.

Installing a fuse of incorrect rating may seriously damage the electrical system. You should consult your Hyosung dealer or a qualified service mechanic immediately.

WHEN THE ENGINE REFUSES TO START

● TROUBLE SHOOTING

If the engine refuses to start, perform the following inspections to determine the cause.

● Fuel Supply Check

- ① Is there enough fuel in the fuel tank?
- ② Make sure there is enough fuel reaching the carburetor from the fuel pump.

● Ignition System Check

- ① Remove a spark plug and reattach to the spark lead.
- ② Holding the spark plug firmly against the crankcase of the engine, push the starter switch with the ignition switch in the "ON" position, the engine stop switch in the "○" position, the transmission in neutral, the side stand up and the clutch disengaged.

If the ignition system is operating properly, a blue spark should jump a cross the spark plug gap.

- ③ If there is no spark, clean the spark plug. Replace it if necessary. Retry the above procedure with the cleaned spark plug or new one.
- ④ If there is still no spark, consult your **Hyosung** dealer for repairs.

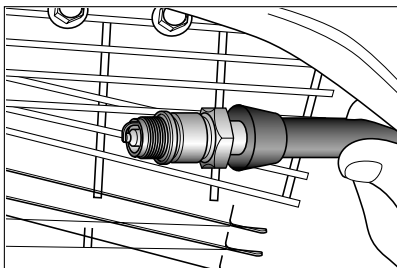

● Engine Stalling

- ① Check the fuel supply in the fuel tank.
- ② Check the ignition system for intermittent spark.
- ③ Check the engine idle speed.

⚠ CAUTION

When any trouble occurs, the best way is to consult your Hyosung dealer for repairs.

⚠ WARNING

Performing the spark test improperly can cause a high voltage electrical shock or an explosion.

Avoid performing this check if you are not familiar with this procedure, or if you have a heart condition or wear a pacemaker. Keep the spark plug away from the spark plug hole during this test.

WHEN KEEPING FOR LONG PERIOD

1. Supply the enough fuel in the fuel tank.
2. Do drain wholly the fuel in the carburetor.
3. Remove the battery from the motorcycle.

CLEANING PROCEDURE

A thorough cleaning of your motorcycle is a necessary part of maintenance and will help keep your motorcycle looking and performing its best. Proper cleaning can also extend the life of your motorcycle.

It is important to clean and inspect your motorcycle after every ride if it is used in mud, brush, grass, water, salt water, or very dusty conditions.

The build-up of mud, brush, grass, etc., especially on the engine and exhaust system, can reduce engine cooling, conceal damage, or increase wear of certain parts. It is important to remove all debris during cleaning.

CAUTION

High pressure washers can damage your motorcycle. (especially the radiator pin)

High pressure washers such as those found at coin-operated car washes have enough pressure to damage the parts of your motorcycle. It may cause rust, corrosion and increase wear.

Do not use high pressure washers to clean your motorcycle.

⊙ WASHING YOUR motorcycle

With some care, your motorcycle can be washed in a similar manner to washing an automobile.

NOTE

Avoid spraying or allowing water to flow over the following places :

- Spark plug
- Fuel tank cap
- Carburetor

Use a garden hose at low pressure to remove the majority of dirt or other debris. Wash your motorcycle by hand with a mild soap or detergent and water. Try to thoroughly remove all dirt and debris without excessive water pressure. Cloth rags, washing mitts or cleaning brushes can be used, be careful with brushes as they may scratch plastic or painted surfaces. Rinse the motorcycle thoroughly with clean water. Dry all areas using a chamois or soft absorbent cloth.

⊙ INSPECTION AFTER CLEANING

Remove the rags or wrapping from the exhaust pipe. For extended life of your motorcycle, lubricate according to "GENERAL LUBRICATION" section.

WARNING

Operating motorcycle with wet brakes can be hazardous.

Wet brakes may not provide as much stopping power as dry brakes. This could lead to an accident.

Test your brakes washing motorcycle, riding at slow speed. If necessary, apply brakes several times to let friction dry out the pads.

Follow the procedures in the "INSPECTION BEFORE RIDING" section to check your motorcycle for any problems that may have arisen during your last ride.

LABEL

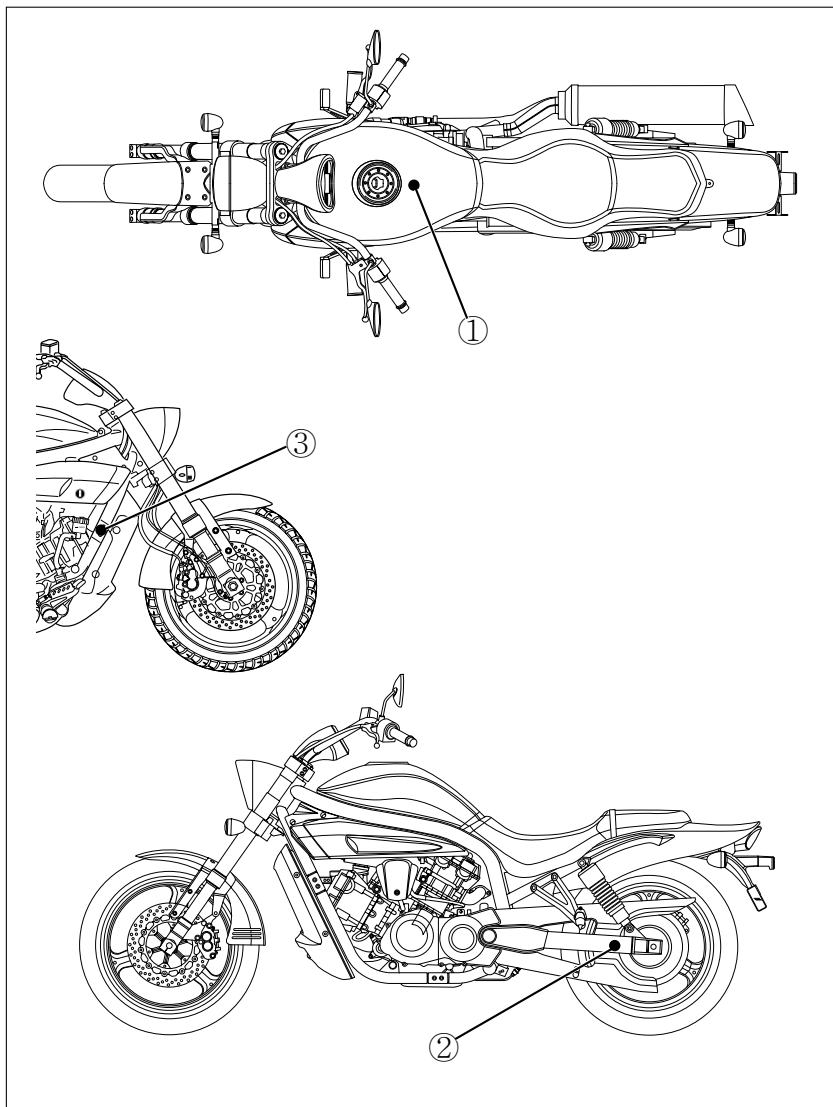

WARNING

- BE FULLY AWARE OF THE OWNER'S MANUAL BEFORE OPERATING AND RIDING.
- MAKE SURE TO WEAR A HELMET.
- OBSERVE THE RESTRICTED SPEED.
- DO NOT BE TOUCHED ON MUFFLER BECAUSE IT IS HOT.
- DO NOT MAKE ILLEGAL MODIFICATION FOR THE SAFE RIDING.
- TAKE THE INSPECTION AND THE MAINTENANCE ACCORDING TO THE REGULAR CHECKLIST OF THE OWNER'S MANUAL.
- THE CHECKLIST BEFORE RIDING
- DASHBOARD, HORN, LAMP, OIL, BRAKE, TIRE (AIR PRESSURE, DAMAGE, ABNORMAL WEAR AND ETC.)
- USE THE HYOSUNG GENUINE OIL.

© 66319H05350-PL

①

WARNING

- AN IMPROPER TIRE PRESSURE CAN CAUSE DIFFICULTIES IN HANDLING, SERIOUS INJURIES OR DEATH.
- BEFORE RIDING, INSPECT THE TIRE PRESSURE, DAMAGE, ABNORMAL WEAR AND ETC. ACCORDING TO THE "INSPECTION BEFORE RIDING"
- ALWAYS MAINTAIN A PROPER TIRE PRESSURE AS SHOWN IN THE BELOW.

| | FRONT | REAR |
|-------------|----------------------------------|----------------------------------|
| SOLO RIDING | 33 psi (2.25kg/cm ²) | 36 psi (2.50kg/cm ²) |
| DUAL RIDING | 33 psi (2.25kg/cm ²) | 42 psi (2.90kg/cm ²) |
| TIRE SIZE | 120/70 ZR 18 59W | 180/55 ZR 17 73W |

66320HP9550-PL

②

HYOSUNG MOTORS & MACHINERY INC.

e9*2002/24*0050

KM4

89 dB(A) – 4500 min⁻¹

③

SPECIFICATIONS

DIMENSIONS AND DRY MASS

| | |
|------------------|-------------------|
| Overall length | 2,430mm (95.7 in) |
| Overall width | 840mm (33.1 in) |
| Overall height | 1,155mm (45.5 in) |
| Wheelbase | 1,665mm (65.6 in) |
| Ground clearance | 160mm (6.3 in) |
| Mass | 220kg (485 lbs) |

ENGINE

| | |
|---------------------|---|
| Type | Four-stroke, DOHC, Liquid-cooled |
| Number of cylinder | V-2 cylinder |
| Bore | 81.5mm (3.21 in) |
| Stroke | 62.0mm (2.44 in) |
| Piston displacement | 647 _{cm³} (39.5 in ³) |
| Carburetor | BDSR39 TYPE(DOUBLE) |
| Starter system | ELECTRIC STARTER |

TRANSMISSION

| | |
|-----------------|--|
| Clutch | Wet multi-plate type |
| Reduction ratio | 2.79 |
| Drive belt | Poly chain belt |
| Transmission | 1st : 2.46 2nd : 1.78 3rd : 1.38 4th : 1.13 5th : 0.96 |

CHASSIS

| | |
|------------------|--------------------|
| Front suspension | Telescopic type |
| Rear suspension | Swingarm type |
| Caster | 35° |
| Trail | 160mm (6.3 in) |
| Steering angle | 35° (right & left) |
| Front tire size | 120/70 - ZR 18 59W |
| Rear tire size | 180/55 - ZR 17 73W |
| Front brake | Double disk |
| Rear brake | Disk |

ELECTRICAL

| | |
|--------------------|--------------------------------------|
| Ignition type | “Igniter” type |
| Ignition timing | 5° B.T.D.C. at 1,500rpm |
| Spark plug | CR8E |
| Battery | 12V 12Ah (MF) |
| Fuse | Main : 30A, Head lamp : 15A |
| Head lamp | HI : 12V - 60W×1 LO : 12V - 55W×1 |
| License plate lamp | 12V - 5W×1 |
| Turn signal lamp | 12V - 10W×4 |
| Brake / Tail lamp | LED type |

CAPACITIES

| | |
|------------|---|
| Fuel tank | 16.0 <i>l</i> |
| Engine oil | 3,000 <i>ml</i> (Replace) 3,200 <i>ml</i> (Oil filter replace) 3,400 <i>ml</i> (Overhaul) |

CONSUMER INFORMATION



HYOSUNG MOTORS & MACHINERY INC.

77, SUNGSAN-DONG, CHANGWON-SHI,
KYUNGNAM, SOUTH KOREA

REPORTING OF SAFETY DEFECTS

If you believe that your vehicle has a defect which could cause a crash or could cause injury or death, you should immediately inform the National Highway Traffic Safety Administration (NHTSA) in addition to notifying Hyosung Motors & Machinery Inc.

If NHTSA receives similar complaints, it may open an investigation, and if it finds that a safety defect exists in a group of vehicles, it may order a recall and remedy campaign.

However, NHTSA cannot become involved in any individual problems between you, your dealer, or Hyosung Motors & Machinery Inc.

To contact NHTSA, you may either call the Auto Safety Hotline toll-free at 1-800-424-9393 (366-0123 in Washington, D.C. area) or write to :

NHTSA
U.S. DEPARTMENT of TRANSPORTATION
400 7th Street SW, (NSA-11)
Washington, D.C. 20590.

You can also obtain other information about motor vehicle safety from the Hotline.

MEMO

MEMO



Prepared by

HYOSUNG MOTORS & MACHINERY INC.

2nd Ed. OCT. 2005.

Printed in KOREA